

FLEX 5000 Standard and Safety I/O Modules

Catalog Numbers 5094-IB16, 5094-IB16XT, 5094-IB16S, 5094-IB16SXT, 5094-OB16, 5094-OB16XT, 5094-OB16S, 5094-OB16SXT, 5094-OW8I, 5094-OW8IXT, 5094-OW4IS, 5094-OW4ISXT



Important User Information

Read this document and the documents listed in the additional resources section about installation, configuration, and operation of this equipment before you install, configure, operate, or maintain this product. Users are required to familiarize themselves with installation and wiring instructions in addition to requirements of all applicable codes, laws, and standards.

Activities including installation, adjustments, putting into service, use, assembly, disassembly, and maintenance are required to be carried out by suitably trained personnel in accordance with applicable code of practice.

If this equipment is used in a manner not specified by the manufacturer, the protection provided by the equipment may be impaired.

In no event will Rockwell Automation, Inc. be responsible or liable for indirect or consequential damages resulting from the use or application of this equipment.

The examples and diagrams in this manual are included solely for illustrative purposes. Because of the many variables and requirements associated with any particular installation, Rockwell Automation, Inc. cannot assume responsibility or liability for actual use based on the examples and diagrams.

No patent liability is assumed by Rockwell Automation, Inc. with respect to use of information, circuits, equipment, or software described in this manual.

Reproduction of the contents of this manual, in whole or in part, without written permission of Rockwell Automation, Inc., is prohibited.

Throughout this manual, when necessary, we use notes to make you aware of safety considerations.



WARNING: Identifies information about practices or circumstances that can cause an explosion in a hazardous environment, which may lead to personal injury or death, property damage, or economic loss.



ATTENTION: Identifies information about practices or circumstances that can lead to personal injury or death, property damage, or economic loss. Attentions help you identify a hazard, avoid a hazard, and recognize the consequence.

IMPORTANT Identifies information that is critical for successful application and understanding of the product.

Labels may also be on or inside the equipment to provide specific precautions.



SHOCK HAZARD: Labels may be on or inside the equipment, for example, a drive or motor, to alert people that dangerous voltage may be present.



BURN HAZARD: Labels may be on or inside the equipment, for example, a drive or motor, to alert people that surfaces may reach dangerous temperatures.



ARC FLASH HAZARD: Labels may be on or inside the equipment, for example, a motor control center, to alert people to potential Arc Flash. Arc Flash will cause severe injury or death. Wear proper Personal Protective Equipment (PPE). Follow ALL Regulatory requirements for safe work practices and for Personal Protective Equipment (PPE).

	Preface	9
	Summary of Changes	9
	Manual Conventions	9
	Graphics Indicate Feature Support.....	10
	Terminology.....	11
	Additional Resources	12
	 Chapter 1	
Digital I/O Module Operation in a Logix 5000 Control System	Controller and Software Compatibility	17
	Controller Compatibility	17
	Firmware and Software Compatibility.....	18
	Secure Access to the System	19
	Types of Modules	19
	Module Overview	20
	Ownership	22
	Multiple Owners of FLEX 5000 Input Modules	22
	Configuration Changes in an Input Module with Multiple Owners	23
	Construct a 5094 FLEX 5000 I/O System.....	24
	FLEX 5000 I/O System Power	24
	Before You Begin.....	25
	Configuration via Logix Designer Application.....	25
	Connections for Standard I/O Modules.....	26
	Requested Packet Interval	26
	Connection Types Available with FLEX 5000 Standard I/O Modules.....	27
	Data Types Available with FLEX 5000 Standard I/O Modules.....	27
	Connections for Safety I/O Modules	28
	‘Configured By’ Options for Safety I/O Modules.....	29
	Data Types Available with FLEX 5000 Safety I/O Modules...	30
	Requested Packet Interval	30
	Connection Over an EtherNet/IP Network.....	32
	Input Module Operation	32
	Trigger Events	33
	Output Module Operation.....	33
	Listen Only Mode.....	35
	Protected Operations.....	36
	Considerations Specific to Safety Modules	36
	Single-channel or Dual-channel Mode.....	37
	Use with Safety Controllers	38
	Determine Conformity	38
Obtain Firmware	38	
Safety Precautions	39	
Safety Application Requirements	40	

	Safe State	41
	Configuration Signature and Ownership	42
	Reset FLEX 5000 I/O Safety Modules to Out-of-Box State . . .	43
	Chapter 2	
Common Digital I/O Module Features	Input Module Compatibility	45
	Output Module Capability	46
	Producer/Consumer Communication	46
	Module Data Quality Reporting	47
	Software Configurable	48
	Fault and Status Reporting	48
	Module Firmware	48
	Module Inhibiting	49
	Electronic Keying	50
	Chapter 3	
Input Module Features	Data Transfer at RPI	51
	Software Configurable Input Filters and Delays	52
	Field Power Loss Detection	52
	Fault and Status Reporting	53
	Chapter 4	
Output Module Features	Features Specific to All FLEX 5000 Output Modules	56
	Output State Change Time	56
	Configurable Point-level Output State in Program Mode or Communications Fault Mode	56
	Connection Fault Handling	57
	Output Behavior Immediately After a Connection Fault	57
	Output State Once Connection Is Re-established	58
	Forcing	58
	Enable Forces	58
	Disable or Remove a Force	59
	Check Force Status	59
	GSV Instruction	60
	Data Echo	60
	Field Power Loss Detection	60
	Fault and Status Reporting	61
	Features Specific to Only Standard and Safety Solid-state Output Modules	61
	No Load Detection	61
	Short-Circuit Protection	62
	Thermal Shutoff	63
	Features Specific to Only Standard Output Modules	64
	Time-scheduled Output Control	64
	Use a MAOC Instruction with a 5094-OB16 or 5094-OB16XT Standard Output Module	65

	Feature Specific to Only Relay Output Modules	67
	Isolated Output	67
	Chapter 5	
Safety I/O Module Features	Safety Input Module Features	69
	Safety Application Suitability Levels	69
	Input Modules in CIP Safety Systems	70
	Use Test Output with a Safety Input	71
	Single-channel Mode	73
	Safety Input Fault Reset	74
	Safety Input Delay	75
	Safety Output Module Features	77
	Safety Application Suitability Levels	77
	Output Module in CIP Safety Systems	78
	Safety and Safety Pulse Test Mode	79
	Single-channel Mode	80
	Dual-channel Mode	81
	Surge Capability of Safety Output	82
	Safety Output Fault Reset	83
	Safety Relay Output Module Features	84
	Safety Application Suitability Levels	84
	Safety Relay Output Module in CIP Safety Systems	84
	Safety Relay Output Fault Reset	85
	Fault and Status Reporting	85
	Chapter 6	
Configure the Standard Module	Before You Begin	88
	Create a New Module	88
	Discover Modules	89
	New Module	91
	Edit the Module Configuration Common Categories	93
	General Category	93
	Connection Category	95
	Module Info Category	96
	Edit 5094-IB16 Module Configuration Categories	97
	Counters Category	97
	Points Category	98
	Events Category	100
	Time Sync Category	102
	Edit 5094-OB16 Module Configuration Categories	103
	Points Category	103
	Edit 5094-OW8I Module Configuration Categories	104
	Points Category	104
	View the Module Tags	105

	Chapter 7	
Configure and Replace Safety Modules	Before You Begin.....	108
	Create a New Module	108
	New I/O Module.....	108
	Edit the Module Configuration Common Categories	110
	General Category.....	111
	Connection Category.....	113
	Safety Category.....	114
	Module Info Category	115
	Edit the 5094-IB16S or 5094-IB16SXT Module	
	Configuration Categories	115
	Input Points Category	116
	Test Output Points Category.....	116
	Edit the 5094-OB16S or 5094-OB16SXT Module	
	Configuration Category	117
	Edit the 5094-OW4IS or 5094-OW4ISXT Module	
	Configuration Category	117
	View the Module Tags.....	118
Replace a Module	118	
Set the SNN Manually.....	119	
Reset to Out-of-Box Configuration	120	
Replace a Module in a Logix 5000 System.....	121	
	Appendix A	
Troubleshoot Your Module	SA Power Indicator	124
	Module Status Indicator	125
	FLEX 5000 Digital Input Modules Status Indicators	126
	FLEX 5000 Output Modules Status Indicators	127
	FLEX 5000 Safety Input Modules Status Indicators.....	129
	FLEX 5000 Safety Output Modules Status Indicators	130
	FLEX 5000 Safety Relay Output Modules Status Indicators	131
	Use the Logix Designer Application for Troubleshooting.....	132
	Warning Signal in the I/O Configuration Tree	132
	Status and Fault Information in Module Properties Categories	133
Logix Designer Application Tag Editor.....	137	
	Appendix B	
Module Tag Definitions	Tag Name Conventions	140
	Access the Tags	140
	5094-IB16 Module Tags.....	141
	Configuration Tags.....	141
	Input Tags	142
	Output Tags	145
	Event Input Tags	146
Event Output Tags	148	

5094-IB16S Module Tags..... 149
 Input Tags 149
 Test Output Tags 150
 Output Tags 150
 5094-OB16 Module Tags..... 151
 Configuration Tags..... 151
 Input Tags 152
 Output Tags 153
 5094-OB16S Module Tags..... 154
 Input Tags 154
 Output Tags 155
 5094-OW4IS Module Tags 156
 Input Tags 156
 5094-OW8I Module Tags 157
 Configuration Tags..... 157
 Input Tags 158
 Output Tags 158

Appendix C

**Application/Wiring Examples
for Safety I/O Modules**

5094-IB16S and 5094-IB16SXT Module Wiring Diagrams. 160
 5094-OB16S and 5094-OB16SXT Module Wiring Diagrams ... 165
 5094-OW4IS and 5094-OW4ISXT Relay Module
 Wiring Diagrams..... 167

Appendix D

Safety Data for I/O Modules

FLEX 5000 I/O Safety Input Module Safety Data 170
 FLEX 5000 I/O Safety Output Module Safety Data..... 171
 FLEX 5000 I/O Safety Relay Output Module Safety Data 172

Index 173

Notes:

This manual describes how to use FLEX 5000™ standard and safety I/O modules in Logix 5000™ control systems.

Make sure that you are familiar with the following:

- Use of a controller in a Logix 5000 control system
- Use of an EtherNet/IP™ network, if the digital I/O modules are installed in a remote location from the controller that is accessible via the EtherNet/IP network
- Use of safety systems
- Studio 5000 Logix Designer® environment

Summary of Changes

This manual was revised to add information about FLEX 5000 I/O safety modules. This table indicates where new content exists in the manual.

Topic	Page
Added safety catalog numbers 5094-0W4IS and 5094-0W4ISXT	Throughout
Updated Chapter 5, Safety I/O Module Features	69
Updated Chapter 7, Configure and Replace Safety Modules	107
Updated Appendix C, Application/Wiring Examples for Safety I/O Modules	159
Updated Appendix D, Safety Data for I/O Modules	169

Manual Conventions

Within this manual, we simplified product names and added product icons for your ease of use.

We use **standard** module to indicate a module that does not have functional safety capability. We use **safety** module to indicate a module with functional safety capability (catalog numbers ending in “S” or “SXT”). Further, we use FLEX 5000 I/O module to indicate when a concept or task applies to **both** the standard and safety digital I/O modules.

Graphics Indicate Feature Support

Throughout this manual, graphics appear with section titles to indicate the digital I/O modules that support the feature that is described in that section.

If both standard and safety modules support a feature, you see icons for both types.

Ownership

Standard Modules



Safety Modules



A controller, also known as the owner-controller, must own every I/O module in a Logix 5000 control system. When the FLEX 5000 I/O modules are used in a Logix 5000 control system, the owner-controller performs the following:

- Stores configuration data for every module that it owns.
- Can reside in a location that differs from the FLEX 5000 I/O modules.
- Sends the I/O module configuration data to define module behavior and begin operation in the control system.

Each FLEX 5000 I/O module must continuously maintain communication with its owner-controller during normal operation.

If only one type of module, standard or safety, supports a feature, you see only one type of icon.

Connections for Standard I/O Modules

Standard Modules



During module configuration, you must define the module. Among the Module Definition parameters, you must choose a connection type for the module. A connection is a real-time data transfer link between the owner-controller and the module that occupies the slot that the configuration references.

When you download module configuration to a controller, the controller attempts to establish a connection to each module in the configuration.

Terminology

This table defines terms that are used in this manual.

Abbreviation	Full Term	Definition
1oo2	One out of Two	Identifies the programmable electronic controller architecture.
CIP™	Common Industrial Protocol	An industrial communication protocol that is used by Logix 5000-based automation systems on EtherNet/IP™, ControlNet®, and DeviceNet® communication networks.
CIP Sync™	Common Industrial Protocol Synchronization	CIP Sync provides the increased control coordination needed for control applications where absolute time synchronization is vital to achieve real-time synchronization between distributed intelligent devices and systems.
CIP Safety™	Common Industrial Protocol – Safety Certified	SIL-rated version of CIP.
—	Connection	Logical communication channel for communication between nodes. Connections are maintained and controlled between masters and slaves.
CL	Claim Limit	The maximum safety integrity level (SIL) that can be achieved.
DC	Diagnostic Coverage	The ratio of the detected failure rate to the total failure rate.
EDS	Electronic Data Sheet	A template that is used in RSNetWorx™ software to display the configuration parameters, I/O data profile, and connection-type support for a given I/O module. RSNetWorx software uses these simple text files to identify products and commission them on a network.
EN	European Norm.	The official European Standard.
ESS	Energy Storage System	Used for backup for memory retention at powerdown on Compact GuardLogix® 5380 controllers. The ESS is inside the controller and cannot be removed.
GSV	Get System Value	A ladder logic instruction that retrieves specified controller status information and places it in a destination tag.
MTTF	Mean Time To Failure	The length of time that a device or other product is expected to remain reliable in operation.
—	Multicast	The transmission of information from one sender to multiple receivers.
NAT	Network Address Translation	The translation of an Internet Protocol (IP) address to another IP address on another network.
ODVA	Open DeviceNet Vendor Association	A nonprofit association of vendors that are established for the promotion of CIP networks.
PC	Personal computer	Computer that is used to interface with and control a Logix-based system via the Studio 5000® environment.
PFD	Probability of Failure on Demand	The average probability of a system to fail to perform its design function on demand.
PFH	Average frequency of a dangerous failure per hour	The probability of a system to have a dangerous failure occur per hour.
PL	Performance Level	ISO 13849-1 safety rating.
—	Proof test	Periodic test that detects failures in a safety-related system so that, if necessary, the system can be restored to an as-new condition or as close as practical to this condition.
—	Safety (devices)	Devices or portions of devices that have functional safety capability.
SIL	Safety Integrity Level	A relative level of risk-reduction provided by a safety function, or to specify a target level of risk reduction.
SNN	Safety Network Number	A unique number that identifies a section of a safety network.
SRT	Safety Reaction Time	A consideration of delays or latencies within the safety system.
SSV	Set System Value	A ladder logic instruction that sets controller system data.
—	Standard (devices)	Devices or portions of devices that do not have functional safety capability.
—	Unicast	The transmission of information from one sender to one receiver.

Additional Resources

These documents contain additional information concerning related products from Rockwell Automation.

Table 1 - Additional Resources

Resource	Description
FLEX 5000 I/O Modules Specifications Technical Data, publication 5094-TD001	Provides specifications for FLEX 5000 EtherNet/IP adapters and FLEX 5000 modules.
FLEX 5000 EtherNet/IP Adapters with RJ45 Ports Installation Instructions, publication 5094-IN001	Describes how to install and wire the 5094-AENTR, 5094-AENRXT, 5094-AEN2TR, and 5094-AEN2TRXT EtherNet/IP adapters.
FLEX 5000 EtherNet/IP Adapters with SFP Support Installation Instructions, publication 5094-IN002	Describes how to install and wire the 5094-AENSFPRXT and 5094-AEN2SFPRXT EtherNet/IP adapters.
FLEX 5000 Digital 16-point Sinking Input Modules Installation Instructions, publication 5094-IN003	Describes how to install and wire the 5094-IB16 and 5094-IB16XT digital input modules.
FLEX 5000 Digital 16-point Sourcing Output Modules Installation Instructions, publication 5094-IN004	Describes how to install and wire the 5094-OB16 and 5094-OB16XT digital output modules.
FLEX 5000 Digital 8-point Isolated Relay Output Modules Installation Instructions, publication 5094-IN005	Describes how to install and wire the 5094-OW8I and 5094-OW8IXT digital output modules.
FLEX 5000 Analog 8-channel Current/Voltage Input Modules Installation Instructions, publication 5094-IN006	Describes how to install and wire the 5094-IF8 and 5094-IF8XT analog input modules.
FLEX 5000 Analog 8-channel Current/Voltage Output Modules Installation Instructions, publication 5094-IN007	Describes how to install and wire the 5094-OF8 and 5094-OF8XT analog output modules.
FLEX 5000 Analog 8-channel Current/Voltage/RTD/ Thermocouple Input Modules Installation Instructions, publication 5094-IN008	Describes how to install and wire the 5094-IY8 and 5094-IY8XT analog input modules.
FLEX 5000 High-speed Counter I/O Modules Installation Instructions, publication 5094-IN009	Describes how to install and wire the 5094-HSC and 5094-HSCXT high-speed counter I/O modules.
FLEX 5000 Terminal Base Assembly Modules Installation Instructions, publication 5094-IN010	Describes how to install and wire the terminal base assemblies for the FLEX 5000 system.
FLEX 5000 Digital 16-point Sinking Safety Input Modules Installation Instructions, publication 5094-IN012	Describes how to install and wire the 5094-IB16S and 5094-IB16SXT digital safety input modules.
FLEX 5000 Digital 16-point Sourcing Safety Output Modules Installation Instructions, publication 5094-IN013	Describes how to install and wire the 5094-OB16S and 5094-OB16SXT digital safety output modules.
FLEX 5000 Relay 4-point Safety Output Modules Installation Instructions, publication 5094-IN015B	Describes how to install and wire the 5094-OW4IS and 5094-OW4ISXT digital relay safety output modules.
FLEX 5000 Analog I/O Modules User Manual, publication 5094-UM002	Describes how to configure, operate, and troubleshoot FLEX 5000 analog I/O modules.
FLEX 5000 High-speed Counter I/O Modules User Manual, publication 5094-UM003	Describes how to configure, operate, and troubleshoot FLEX 5000 high-speed counter modules.
CompactLogix 5380 Controllers User Manual, publication 5069-UM001	Describes how to configure, operate, and troubleshoot CompactLogix™ 5380 controllers.
EtherNet/IP Communication Modules in 5000 Series Control Systems User Manual, publication ENET-UM004	Describes how to configure, operate, and troubleshoot the FLEX 5000 EtherNet/IP adapters.
Integrated Architecture and CIP Sync Configuration Application Technique, publication IA-AT003	Provides information about CIP Sync technology and how to synchronize clocks within the Rockwell Automation Integrated Architecture® system.
Electronic Keying in Logix5000 Control Systems Application Technique, publication LOGIX-AT001	Describes how to use electronic keying in Logix 5000 control system applications.
Logix5000 Controllers Tasks, Programs, and Routines Programming Manual, publication 1756-PM005	Provides more information on event tasks and event task configuration.

Table 1 - Additional Resources

Position-based Output Control with the MAOC Instruction, publication 1756-AT017	Describes how to configure time-scheduled output control with the MAOC instruction.
Industrial Automation Wiring and Grounding Guidelines, publication 1770-4.1	Provides general guidelines for installing a Rockwell Automation industrial system.
Product Certifications website, http://www.rockwellautomation.com/rockwellautomation/certification/overview.page	Provides declarations of conformity, certificates, and other certification details.
SISTEMA software utility, http://marketing.rockwellautomation.com/safety/en/Sistema_Download	The Rockwell Automation SISTEMA data library is available for download, together with a link to the SISTEMA download site.

You can view or download publications at

<http://www.rockwellautomation.com/global/literature-library/overview.page>.

To order paper copies of technical documentation, contact your local Allen-Bradley distributor or Rockwell Automation sales representative.

Notes:

Digital I/O Module Operation in a Logix 5000 Control System

Topic	Page
Controller and Software Compatibility	17
Before You Begin	25
Secure Access to the System	19
Types of Modules	19
Module Overview	20
Ownership	22
Construct a 5094 FLEX 5000 I/O System	24
Configuration via Logix Designer Application	25
Connections for Standard I/O Modules	26
Connections for Safety I/O Modules	28
Connection Over an EtherNet/IP Network	32
Input Module Operation	32
Output Module Operation	33
Listen Only Mode	35
Protected Operations	36
Considerations Specific to Safety Modules	36
Use with Safety Controllers	38

IMPORTANT You cannot use FLEX 5000™ I/O modules with all Logix 5000™ controllers. For example, you can use FLEX 5000 I/O modules with CompactLogix™ 5380 and ControlLogix® 5580 controllers but not with CompactLogix 5370 and ControlLogix 5570 controllers.

You can use FLEX 5000 I/O modules with Logix 5000 controllers as remote I/O modules only.

Throughout this publication, the term **Logix 5000 controller** refers to the controllers with which you can use FLEX 5000 I/O modules in a given capacity. The term does not refer to all Logix 5000 controllers.

For the most current information on the Logix 5000 controllers with which you can use FLEX 5000 I/O modules, see the product description at <http://www.ab.com>.

Logix 5000 controllers use FLEX 5000 standard and safety I/O modules to control devices in a control system. The controllers access the modules over an EtherNet/IP™ network. FLEX 5000 I/O modules use terminal base (TB) assemblies to connect field-side wiring.

FLEX 5000 I/O modules use the Producer/Consumer network communication model. This communication is an intelligent data exchange between modules and other system devices in which each module produces data without first being polled.

You use FLEX 5000 I/O modules as remote I/O modules that are accessible via an EtherNet/IP network. The modules are installed to the right of a FLEX 5000 EtherNet/IP adapter.

Logix 5000 controllers can exchange data with the modules over the network. [Figure 1](#) shows a standard controller with standard I/O modules. Standard controllers **do not** support safety I/O modules.

Figure 1 - FLEX 5000 Standard I/O Modules in a Logix 5000 Control System

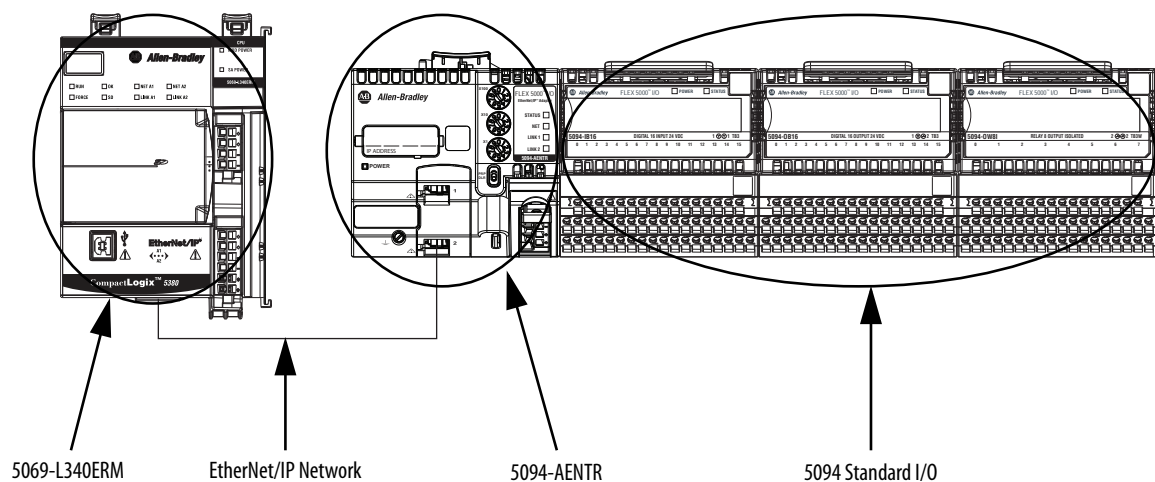

[Figure 2](#) shows a safety controller with standard and safety I/O modules. Safety controllers support both standard and safety I/O modules.

Figure 2 - FLEX 5000 Safety I/O Modules in a Logix 5000 Control System

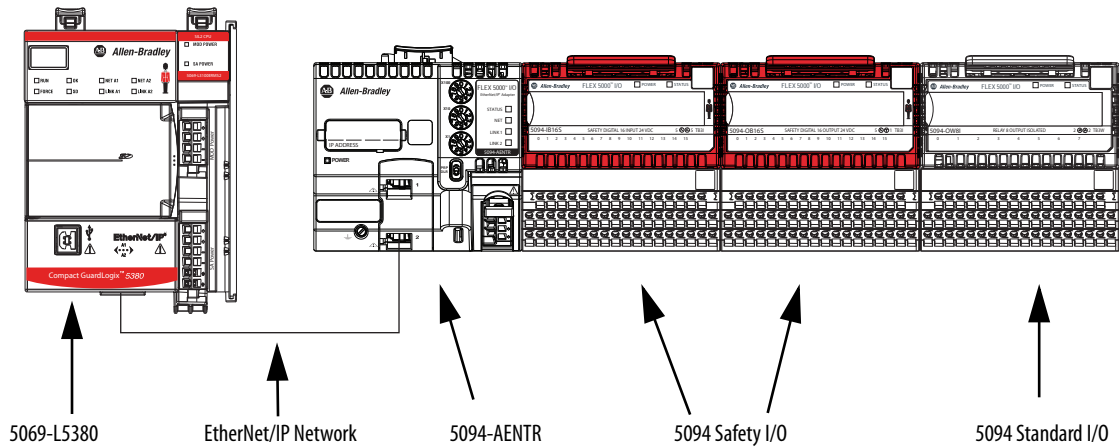

Controller and Software Compatibility

Controller and programming software compatibility requirements apply when you use FLEX 5000 standard and safety I/O modules. A module type and how it is used affect which requirements apply.

You must also consider Logix Designer application version requirements when you design your system. For example, you can use FLEX 5000 safety I/O modules with only version 32 or greater of the Logix Designer application.

Controller Compatibility

Compatibility between Logix 5000 controllers and FLEX 5000 I/O modules varies based on module type, that is, whether the module is standard or safety.

While you must pair safety I/O with a safety controller, you can also pair standard I/O with a safety controller. For example, ControlLogix 5580 controllers are compatible with FLEX 5000 standard I/O modules. GuardLogix® 5580 controllers are compatible with FLEX 5000 standard and safety I/O modules.

Firmware and Software Compatibility

Table 2 describes the module compatibility requirements when you use FLEX 5000 I/O standard and safety modules with Logix 5000 controllers.

IMPORTANT You must use adapter firmware version 3.011 or later with standard I/O firmware version 2.011 and safety I/O modules.

Table 2 - FLEX 5000 I/O Standard and Safety Modules Controller and Software Compatibility Requirements

Modules	Controllers		Logix Designer
	System	Cat. Nos.	Application Version
Standard Modules 5094-IB16, 5094-IB16XT, 5094-OB16, 5094-OB16XT, 5094-OW8I, 5094-OW8IXT	CompactLogix 5380	5069-L320ER, 5069-L340ERM	31.00.00 or later
		5069-L306ER, 5069-L306ERM, 5069-L310ER, 5069-L310ERM, 5069-L310ER-NSE, 5069-L310ERS2, 5069-L320ERM, 5069-L330ER, 5069-L330ERM, 5069-L340ER	31.00.00 or later
		5069-L350ERM, 5069-L380ERM, 5069-L3100ERM	31.00.00 or later
	Compact GuardLogix 5380	5069-L306ERMS2, 5069-L306ERS2, 5069-L310ERS2, 5069-L310ERMS2, 5069-L320ERS2, 5069-L320ERMS2, 5069-L330ERS2, 5069-L330ERMS2, 5069-L340ERS2, 5069-L340ERMS2, 5069-L350ERS2, 5069-L350ERMS2, 5069-L380ERS2, 5069-L380ERMS2, 5069-L3100ERS2, 5069-L3100ERMS2	31.00.00 or later
	ControlLogix 5580	1756-L83E, 1756-L85E	31.00.00 or later
		1756-L81E, 1756-L82E, 1756-L84E	31.00.00 or later
GuardLogix 5580	1756-L81ES, 1756-L82ES, 1756-L83ES, 1756-L84ES	31.00.00 or later	
Safety Modules 5094-IB16S, 5094-IB16SXT, 5094-OB16S, 5094-OB16SXT, 5094-OW4IS, 5094-OW4ISXT	Compact GuardLogix 5380	5069-L306ERMS2, 5069-L306ERS2, 5069-L310ERS2, 5069-L310ERMS2, 5069-L320ERS2, 5069-L320ERMS2, 5069-L330ERS2, 5069-L330ERMS2, 5069-L340ERS2, 5069-L340ERMS2, 5069-L350ERS2, 5069-L350ERMS2, 5069-L380ERS2, 5069-L380ERMS2, 5069-L3100ERS2, 5069-L3100ERMS2	32.00.00 or later
	GuardLogix 5580	1756-L81ES, 1756-L82ES, 1756-L83ES, 1756-L84ES	32.00.00 or later

Secure Access to the System To secure access to the [device] by authorized users only, consider these options:

- Password helps protect the source and execution of the control program
- Remove the key from the controller
- Deploy EtherNet/IP devices in accordance with recommended architectures and concepts. See the Converged Plantwide Ethernet (CPwE) Design and Implementation Guide, publication [ENET-TD001](#).
- Implement physical barriers, such as locked cabinets

To secure access to the system, consider these options:

- Follow industry best practices to harden your personal computers and servers, including anti-virus/anti-malware and application whitelisting solutions.

The recommendations are published at the Rockwell Automation technical support center in Knowledgebase article *Rockwell Automation Customer Hardening Guidelines, #546987*. The technical support center is available at: <https://rockwellautomation.custhelp.com/>

- Develop and deploy backup and disaster recovery policies and procedures. Test backups on a regular schedule.
- Minimize network exposure for all control system devices and systems, and confirm that they are not accessible from the Internet.
- Locate control system networks and devices behind firewalls and isolate them from the business network.
- Subscribe to the Rockwell Automation Security Advisory Index, Knowledgebase article KB54102, so you have access to information about security matters that affect Rockwell Automation products.

Types of Modules

[Table 3](#) describes the types of FLEX 5000 I/O modules.

Table 3 - FLEX 5000 Standard and Safety Digital I/O Modules

Cat. No. ⁽¹⁾	Description
5094-IB16, 5094-IB16XT	18...32V DC 16-point, sinking input module
5094-IB16S, 5094-IB16SXT	18...32V DC 16-point sinking safety input module
5094-OB16, 5094-OB16XT	18...32V DC 16-point, sourcing output module
5094-OB16S, 5094-OB16SXT	18...32V DC 16-point sourcing safety output module
5094-OW4IS, 5094-OW4ISXT	5...240V/125V DC 4-point safety relay output module
5094-OW8I, 5094-OW8IXT	5...240V AC /125V DC 8-point, isolated normally open relay output module

(1) XT modules can operate in extreme environments while non-XT modules cannot.

Module Overview

Figure 3 shows the parts of an example FLEX 5000 standard I/O module.

Figure 3 - Example FLEX 5000 Standard I/O Module

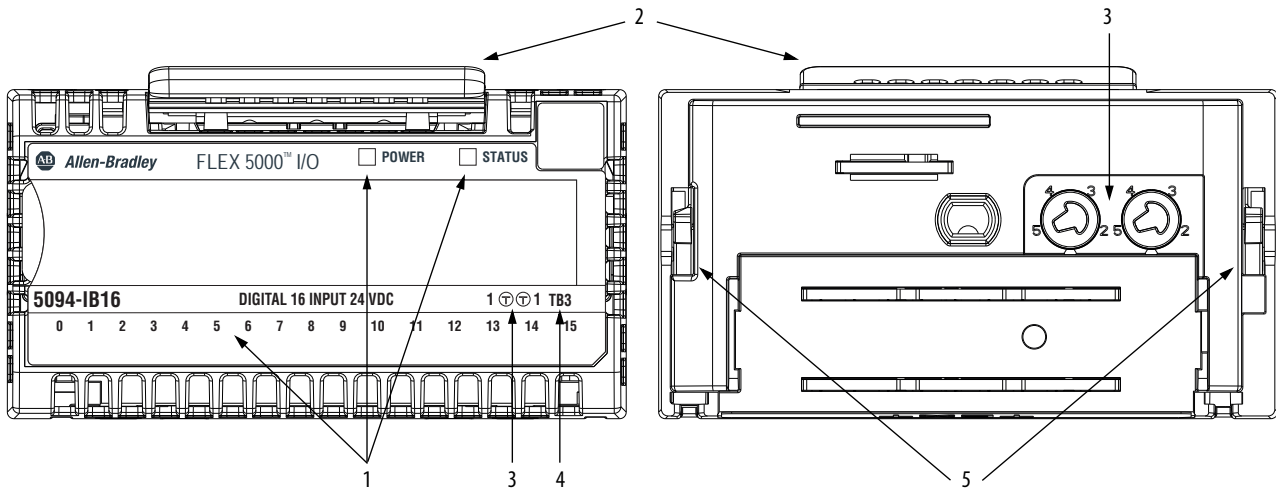

Table 4 - FLEX 5000 Standard I/O Module Parts

Item	Description
1	Status indicators - Displays the status of communication, module health, and input/output devices. Indicators help with troubleshooting anomalies
2	Release lever - Disengages the latching hooks to allow removal of the module from the terminal base assembly
3	Module keying - Indicates the keying position the terminal base assembly must be configured to before installing the module
4	Terminal base - Indicates the type of terminal base assembly to use with the module
5	Latching hooks - Securely installs FLEX 5000 modules on the terminal base assembly

Figure 4 shows the parts of an example FLEX 5000 safety I/O module.

Figure 4 - Example FLEX 5000 Safety I/O Module

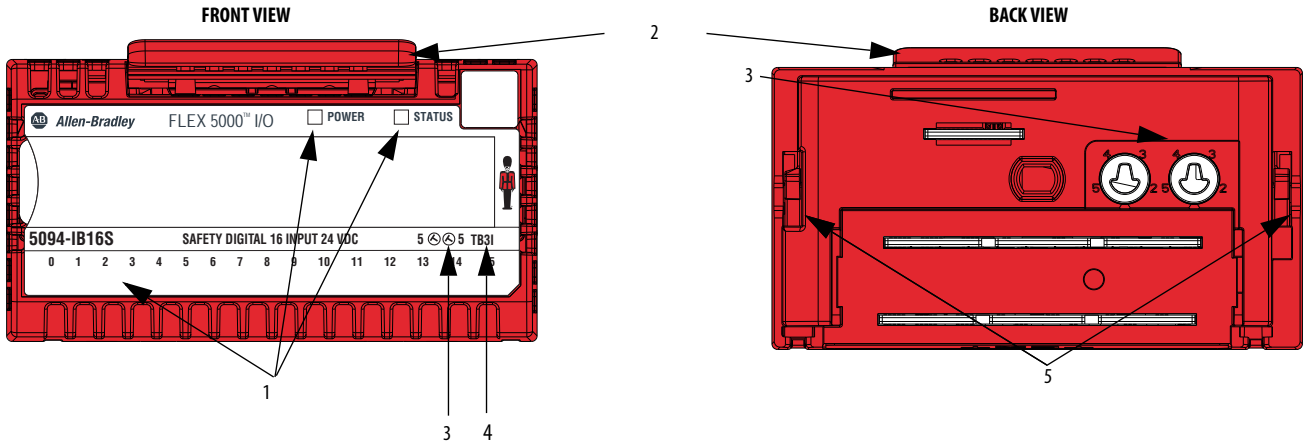
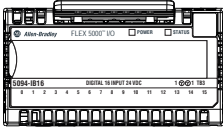

Table 5 - FLEX 5000 Safety I/O Module Parts

Item	Description
1	Status indicators - Displays the status of communication, module health, and input/output devices. Indicators help with troubleshooting anomalies
2	Release lever - Disengages the latching hooks to allow removal of the module from the terminal base assembly
3	Module keying - Indicates the keying position the terminal base assembly must be configured to before installing the module
4	Terminal base - Indicates the type of terminal base assembly to use with the module
5	Latching hooks - Securely installs FLEX 5000 modules on the terminal base assembly

Ownership

Standard Modules



Safety Modules

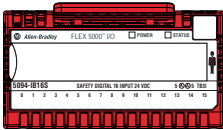

A controller, also known as the owner-controller, must own every I/O module in a Logix 5000 control system. When the FLEX 5000 I/O modules are used in a Logix 5000 control system, the owner-controller performs the following:

- Stores configuration data for every module that it owns.
- Can reside in a location that differs from the FLEX 5000 I/O modules.
- Sends the I/O module configuration data to define module behavior and begin operation in the control system.

Each FLEX 5000 I/O module must continuously maintain communication with its owner-controller during normal operation.

Typically, each I/O module in a FLEX 5000 I/O system has only one owner-controller. Modules with output tags are limited to one owner-controller.

Multiple Owners of FLEX 5000 Input Modules

While typically only one owner-controller is connected to a FLEX 5000 digital input module, multiple Logix 5000 controllers can own FLEX 5000 digital input modules as owner-controllers. In this case, the following conditions must exist:

- The controllers maintain the same configuration.
- The configuration in each controller uses a Data connection to the input module.
- The first controller to make a connection to the input module is the only controller that can change the configuration. Therefore, it 'owns' the module configuration.

IMPORTANT If the controller that owns the module configuration changes the configuration, the other controllers are not notified of any changes. See [Configuration Changes in an Input Module with Multiple Owners on page 23](#) for more information.

- The controllers that do maintain but do not 'own' the module configuration are similar to Listen-only controllers. The difference between the controllers is that the controllers that maintain but do not own the module configuration can use a Multicast or Unicast connection over the EtherNet/IP network.

For more information on Listen-only controllers, see [Listen Only Mode on page 35](#).

Configuration Changes in an Input Module with Multiple Owners

You must be careful when changing the configuration data of an input module in a multiple owner scenario. If the configuration data is changed in owner A and sent to the module, that configuration data is accepted as the new configuration for the module. Owner B continues to listen unaware that any changes have been made in the behavior of the input module, as illustrated.

Figure 5 - Module Configuration Changes with Multiple Owners

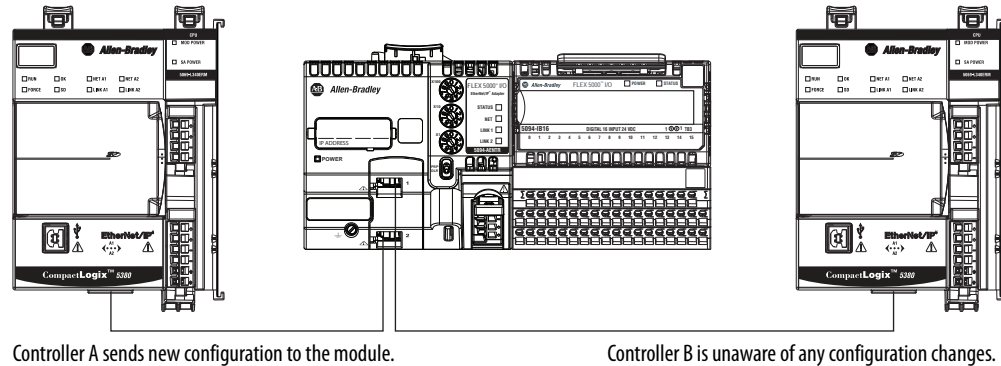

IMPORTANT A message in Logix Designer alerts you to the possibility of a multiple owner-controller situation and lets you inhibit the connection before changing the module configuration. When changing the configuration for a module with multiple owners, we recommend that you inhibit the connection.

To prevent other owner-controllers from receiving potentially erroneous data, use these steps when changing the configuration of a module in a multiple owner scenario while online.

1. For each owner-controller, inhibit the connection to the module either in the software on the Connection tab or the message dialog box warning you of the multiple owner condition.
2. Make the appropriate configuration data changes in the software. For more information about using Logix Designer to change the configuration, see [Chapter 6](#).
3. Repeat [step 1](#) and [step 2](#) for all owner-controllers, making the exact same changes in each.
4. Clear the Inhibit checkbox in each owner-controller configuration.

Construct a 5094 FLEX 5000 I/O System

FLEX 5000 I/O is a small, modular I/O system for distributed applications that performs all of the functions of rack-based I/O. The FLEX system contains the components pictured below.

Adapter

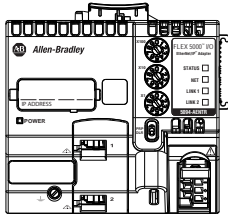

I/O Module

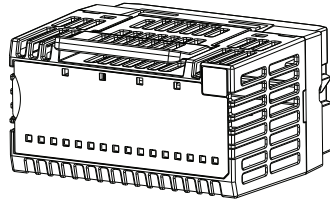

Terminal Base

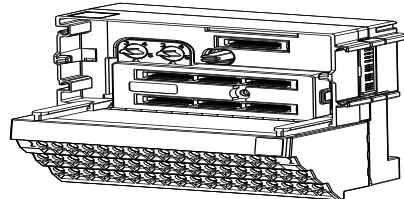

End Caps

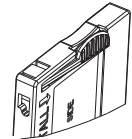

- Adapter - transfers read and write configuration data to and from the I/O module
- Terminal base - contains a terminal strip to terminate wiring for two- or three-wire devices
- I/O modules - contains the bus interface and circuitry needed to perform specific functions related to your application
- End cap - basically a dust cap for the last module in a rack

FLEX 5000 I/O System Power



ATTENTION: Power to this equipment and all connected I/O must be supplied from a source that is isolated from Mains power via an approved isolating transformer constructed with basic insulation.

FLEX 5000 I/O SA Field-Side Power

- FLEX 5000 I/O modules use terminal base (TB) assemblies to connect field-side wiring.
- SA field-side power source is connected to the terminal base (TB) assemblies via SA Power terminals.
- You must limit the SA field-side power source to 10 A, max, at 18...32V DC.
- Confirm that the external module power supply is adequately sized for the total SA field-side power current draw in the module.

For example, if the total module power current draw, including current inrush requirements, is 5 A, you can use a module power supply that is limited to 5 A.

- You must use SELV-listed power supplies for module power if there are functional safety modules that are connected to the FLEX 5000 I/O system.

- Not all power supplies are certified for use in all applications, for example, nonhazardous and hazardous environments.

IMPORTANT We recommend that you use separate external power supplies for the adapter and the adjacent terminal base. This practice can prevent unintended consequences that can result if you use one supply.

For more information, see the publications that are listed in Additional Resources on [page 12](#).

Before You Begin

Before you use your digital I/O module, you must complete the following:

- a. Install a FLEX 5000 EtherNet/IP adapter.
- b. Install the FLEX 5000 I/O modules to the right of the adapter.
- c. Install an EtherNet/IP network.
- d. Install the Logix 5000 controller that accesses the FLEX 5000 I/O modules via an EtherNet/IP network.

Make sure that you have enough FLEX 5000 terminal base (TB) assemblies to satisfy your application needs. For more information, see the FLEX 5000 Terminal Base Assembly Modules Installation Instructions, publication [5094-IN010](#).

IMPORTANT Terminal bases are not included with your module and are not available for purchase. A terminal base consists of a mounting base (MB) and removable terminal block (RTB). You must purchase MBs and RTBs separately and assemble them together.

For adapter information, see the FLEX 5000 EtherNet/IP Adapters with RJ45 Ports Installation Instructions, publication [5094-IN001](#), and the FLEX 5000 EtherNet/IP Adapters with SFP Support Installation Instructions, publication [5094-IN002](#).

Configuration via Logix Designer Application

You must create a Logix Designer application project for the Logix 5000 controller that owns the FLEX 5000 standard and safety I/O modules. The project includes module configuration data for the FLEX 5000 I/O modules.

The Logix Designer application transfers the project to the owner-controller during the program download. Data is then transferred to the FLEX 5000 I/O modules over the EtherNet/IP network.

The FLEX 5000 I/O modules can operate immediately after receiving the configuration data.

Connections for Standard I/O Modules

Standard Modules

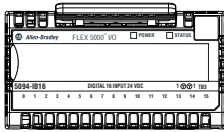

During module configuration, you must define the module. Among the Module Definition parameters, you must choose a connection type for the module. A connection is a real-time data transfer link between the owner-controller and the module that occupies the slot that the configuration references.

When you download module configuration to a controller, the controller attempts to establish a connection to each module in the configuration.

Because part of module configuration includes a slot in the FLEX 5000 I/O system, the owner-controller checks for the presence of a module there. If a module is detected, the owner-controller sends the configuration. One of the following occurs:

- If the configuration is appropriate to the module detected, a connection is made and operation begins.
- If the configuration is not appropriate to the module detected, the data is rejected and the Logix Designer application indicates that an error occurred.

The configuration can be inappropriate for many reasons. For example, a mismatch in electronic keying that helps prevents normal operation.

The owner-controller monitors its connection with a module. Any break in the connection, for example, the loss of power to the FLEX 5000 I/O system, causes a fault. The Logix Designer application monitors the fault status tags to indicate when a fault occurs on a module.

Standard Modules

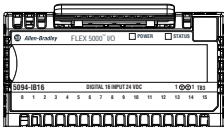

Requested Packet Interval

The Requested Packet Interval (RPI) is a configurable parameter that defines a rate at which the owner-controller and the module exchange data. You set the RPI value during initial module configuration and can adjust it as necessary after module operation has begun. The following are valid RPI values:

- FLEX 5000 I/O standard modules: 0.2...750 ms

IMPORTANT You can change the RPI while the project is online. If you change the RPI while the project is online, however, the connection to the module is closed and reopened in one of the following ways:

- You inhibit the connection to the module, change the RPI value, and uninhibit the connection.
 - You change the RPI value. In this case, the connection is closed and reopened immediately after you apply the change to the module configuration.
-

For more information on guidelines for specifying RPI rates, see the Logix 5000 Controllers Design Considerations Reference Manual, publication [1756-RM094](#).

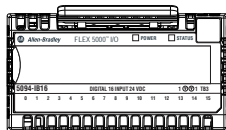
Standard Modules**Connection Types Available with FLEX 5000 Standard I/O Modules**

When configuring a FLEX 5000 standard I/O module, you must define the module. Connection is a required parameter in the Module Definition. The choice determines what data is exchanged between the owner-controller and the module.

[Table 6](#) describes the connection types that you can use with FLEX 5000 I/O modules.

Table 6 - Connections - FLEX 5000 I/O Modules

Connection Type	Description	
	FLEX 5000 Input Modules	FLEX 5000 Output Modules
Data	The module returns the following to the owner-controller: <ul style="list-style-type: none"> General fault data Input data 	The module returns the following to the owner-controller: <ul style="list-style-type: none"> General fault data Output data
Data with Events ⁽¹⁾	The module returns the following to the owner-controller: <ul style="list-style-type: none"> Event fault data Event input data Event output data 	N/A
Listen Only Data Listen Only Data with Events ⁽¹⁾	<p>When a Listen Only Data connection is used, another controller owns the module. A controller that makes a Listen Only Data connection to the module does not write configuration for the module. It merely listens to the data exchanged with the owner-controller.</p> <p>Use Listen Only Data when the connection type is set to Data. Use Listen Only Data with Events when the connection type is set to Data with Events.</p> <p>IMPORTANT: If a controller uses a Listen Only Data connection, the connection must use the Multicast option.</p> <p>For more information on Listen Only connections, see Listen Only Mode on page 35. In this case, all other connections to the module, for example, the connection to the owner-controller must also use the Multicast option.</p>	

(1) Data with Events and Listen Only Data with Events are available only on the 5094-IB16 digital input module.

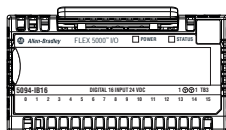
Standard Modules**Data Types Available with FLEX 5000 Standard I/O Modules**

The Module Definition includes a Data parameter that matches the module type. Digital input modules use Input Data, and digital output modules use Output Data.

The module type and Connection choice determine the available Input Data or Output Data choices. For example, you can configure a 5094-IB16 digital input module to use the Connection choice Data with Events. The resulting Input Data choices are Data with Events include Data, Packed Data, or Timestamped Data.

For more information on the Connection and Data parameter choices available with FLEX 5000 I/O modules, see the Logix Designer application.

Connections for Safety I/O Modules

Safety Modules

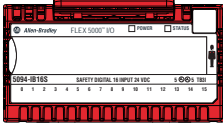

IMPORTANT This section shows some Logix Designer application screens that are used when you configure FLEX 5000 I/O safety modules. For a complete description of how to configure the modules, see [Chapter 7, Configure and Replace Safety Modules on page 107](#).

During module configuration, you must define the module. Among the Module Definition parameters with FLEX 5000 safety I/O modules, you must choose how module is configured.

The choice depends on whether the project is downloaded to the controller that owns the module configuration, that is, the owner-controller, or to a controller that is listening to input modules in a project.

A real-time data transfer link is established between the controller and the module that occupies the slot that the configuration references.

When you download module configuration to a controller, the controller attempts to establish a connection to each module in the configuration.

Because part of module configuration includes a slot number in the remote FLEX 5000 I/O system, the owner-controller checks for the presence of a module there. If a module is detected, the owner-controller sends the configuration. One of the following occurs:

- If the configuration is appropriate to the module detected, a connection is made and operation begins.
- If the configuration is not appropriate to the module detected, the data is rejected and the Logix Designer application indicates that an error occurred.

The configuration can be inappropriate for many reasons. For example, a mismatch in electronic keying that helps prevents normal operation.

The owner-controller monitors its connection with a module. Any break in the connection, for example, the loss of power to a remote FLEX 5000 I/O system, causes a fault. The Logix Designer application monitors the fault status tags to indicate when a fault occurs on a module.

'Configured By' Options for Safety I/O Modules

The 'Configured By' choice determines what data is exchanged between the owner-controller and the module. This is an example Module Definition dialog box, and available Connection choices, for FLEX 5000 I/O safety modules.

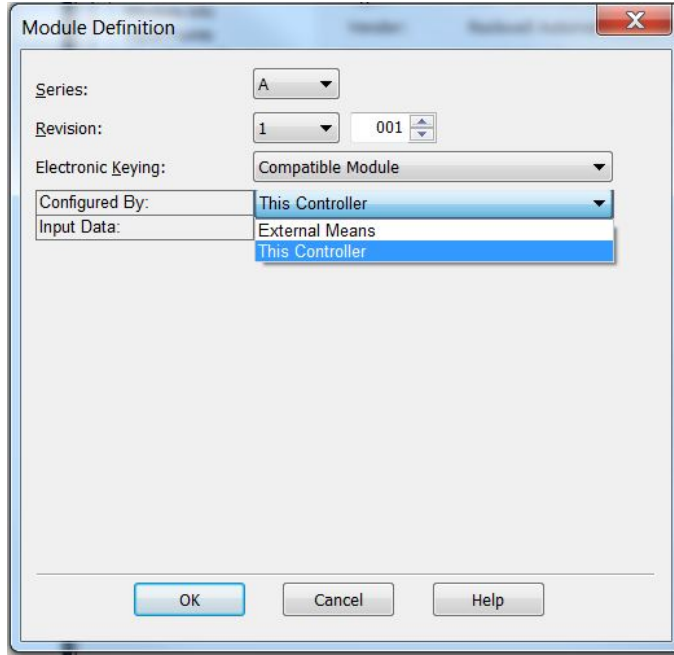

[Table 7](#) describes the connection types that you can use with FLEX 5000 I/O safety modules.

Table 7 - Configured By Choices - FLEX 5000 Safety I/O Modules

Configured by Choice	Description	
	FLEX 5000 Safety Input Module	FLEX 5000 Safety Output Module
This controller	The module returns the following to the owner-controller: <ul style="list-style-type: none"> • General fault data • Safety input data 	The module exchanges the following with the owner-controller: <ul style="list-style-type: none"> • General fault data • Safety input data • Safety output data
External means	When the External Means option is chosen, another controller owns the module. A controller that chosen this option does not write configuration for the module. It merely listens to the data exchanged with the owner-controller. That is, it receives Safety input data.	

Data Types Available with FLEX 5000 Safety I/O Modules

The Module Definition includes a Data parameter that matches the module type. Safety input modules use Input Data, and safety output modules use Output Data.

The module type and Connection choice determine the available Input Data or Output Data choices. We recommend that you use Safety Data as the Input Data choice unless you need to use Safety Packed Data⁽¹⁾ for backward application compatibility.

For more information on the Connection and Data parameter choices available with FLEX 5000 I/O modules, see the Logix Designer application.

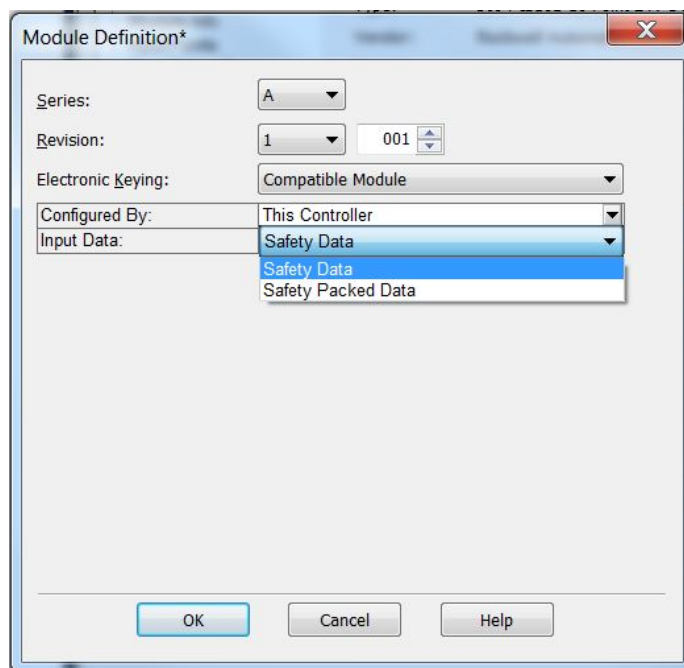

Requested Packet Interval

The requested packet interval (RPI) is a configurable parameter that defines a rate at which the owner-controller and the module exchange data. You set the RPI value during initial module configuration and can adjust it as necessary after module operation has begun.

The valid RPI values for FLEX 5000 I/O safety modules are 2...500 ms.

(1) Safety Packed Data is not available for the 5094-0W4IS and 5094-0W4ISXT modules.

-
- IMPORTANT** You can change the RPI while the project is online. If you change the RPI while the project is online, however, the connection to the module is closed and reopened in one of the following ways:
- You inhibit the connection to the module, change the RPI value, and uninhibit the connection.
 - You change the RPI value. In this case, the connection is closed and reopened immediately after you apply the change to the module configuration.
-

Connection Reaction Time Limit With FLEX 5000 I/O Safety Modules

Setting the RPI on FLEX 5000 I/O safety modules is not as straightforward as setting it on FLEX 5000 I/O digital modules. With FLEX 5000 I/O safety modules, the Connection Reaction Time Limit configuration affects the RPI that is used for a module.

The Connection Reaction Time Limit defines the predicted period of safety packets on the associated connection. If the Max Network Delay exceeds the Connection Reaction Time Limit, a connection fault occurs.

By default, the Connection Reaction Time Limit is four times the RPI.

Use the default values for Timeout Multiplier (2) and Network Delay Multiplier (200). The Network Delay Multiplier value is in terms of percentage. Thus, 200 means 200%.

-
- IMPORTANT** To determine what is appropriate, analyze each safety channel. The default Timeout Multiplier of 2 and Network Delay Multiplier of 200 creates a worst-case input connection reaction time limit of 4 times the RPI, and an output connection reaction time limit of 3 times the RPI.
- Changes to these parameters must be approved only after a thorough review by a safety administrator.
-

For more information on specifying RPI rates, see the following:

- FLEX 5000 I/O safety I/O modules - page [30](#)
- Logix 5000 Controllers Design Considerations Reference Manual, publication [1756-RM094](#)

Connection Over an EtherNet/IP Network

During module configuration, you must configure the Connection over EtherNet/IP parameter. The configuration choice dictates how input data is broadcast over the network.

The FLEX 5000 I/O modules use one of the following methods to broadcast data:

- Multicast - Data is sent to all network devices
- Unicast - Data is sent to a specific controller depending on the module configuration

Unicast is the default setting. We recommend that you use Unicast because it reduces network bandwidth usage.

Input Module Operation

Logix 5000 controllers do not poll the FLEX 5000 input modules for input data. Instead, the input modules send data at the RPI.

FLEX 5000 input modules reside in a FLEX 5000 I/O system that is accessible to a Logix 5000 controller over an EtherNet/IP network. A FLEX 5000 EtherNet/IP adapter is the first component in a FLEX 5000 I/O system and connects the system to the EtherNet/IP network.

FLEX 5000 input modules communicate input data to the FLEX 5000 EtherNet/IP adapter at the defined RPI. The input data consists of point and status data.

At the RPI, the following events occur.

1. The digital input module scans its points for input data.
2. The module sends the data to the FLEX 5000 EtherNet/IP adapter.
3. The FLEX 5000 EtherNet/IP adapter in the FLEX 5000 I/O system sends the data over the EtherNet/IP network.
4. One of the following:
 - If the controller is directly connected to the EtherNet/IP network, it receives the input data immediately.
 - If the controller is connected to the EtherNet/IP network through another communication module, the module sends the data to its backplane and the controller receives it.

Trigger Events

IMPORTANT FLEX 5000 I/O safety input modules cannot trigger events.

A FLEX 5000 standard input module can trigger as many as four events. The module can also trigger an Event task to execute in the owner-controller. The event task lets you execute a section of logic immediately when an event occurs.

For more information on event tasks, see the Logix5000 Controllers Tasks, Programs, and Routines Programming Manual, publication [1756-PM005](#).

Output Module Operation

The controller sends data to an output module at the RPI or after an Immediate Output (IOT) instruction is executed.

IMPORTANT Immediate Output instruction is not supported in safety applications.

The RPI defines when the controller sends data to the FLEX 5000 standard output module and when the output module echoes data. The controller sends data to an output module only at the RPI.

At the RPI, not only does the controller send data to the output module, but also the output module sends data to the controller. For example, the output module sends an indication of the point data quality.

IMPORTANT The RPI for a FLEX 5000 I/O safety output module is the Safety Task period. Safety output data is sent at the completion of the Safety Task scan.

FLEX 5000 output modules reside in a FLEX 5000 I/O system that is accessible to a Logix 5000 controller over an EtherNet/IP network. A FLEX 5000 EtherNet/IP adapter is the first component in a FLEX 5000 I/O system and connects the system to the EtherNet/IP network.

FLEX 5000 output modules receive output data from a controller. The output module also sends data to the controller.

Controller to Output Module Data Transmission

The controller broadcasts data to its local backplane at one of the following:

- RPI
- An IOT instruction is executed (standard I/O modules only)

IMPORTANT An IOT instruction sends data to all of the output modules in the system immediately, and resets the RPI timer.

Based on the RPI rate and the length of the controller program scan, the output module can receive and echo data multiple times during one program scan.

When the RPI is less than the program scan length, the output points can change values multiple times during a program scan. The owner-controller does not depend on the program scan to complete to send data.

These events occur when the controller sends data to a FLEX 5000 output module.

1. Data is sent in one of the following ways:
 - If the controller is directly connected to the EtherNet/IP network, it broadcasts data to the network.
In this case, skip to [step 3](#).
 - If the controller is connected to the EtherNet/IP network via a communication module, the controller transmits the data to the backplane.
In this case, proceed to [step 2](#).
2. The EtherNet/IP communication module transmits the data to the EtherNet/IP network.
3. The FLEX 5000 EtherNet/IP adapter in the FLEX 5000 I/O system receives the data from the network and transmits it to the backplane.
4. The digital output module receives the data from the backplane and behaves as dictated by its configuration.

Output Module to Controller Data Transmission

When a FLEX 5000 output module receives new data and the requested data value is present on the RTB, the output module sends, or ‘echoes’, a data value back to the controller and to the rest of the control system. The data value corresponds to the signal present at its terminals. This feature is called [Data Echo](#).

In addition to the Data Echo, the output module sends other data to the controller at the RPI. For example, the module alerts the controller if a short circuit condition exists on the module.

The following events occur when a FLEX 5000 output module sends data to the controller at the RPI.

1. The module sends the data to the backplane.
2. The FLEX 5000 EtherNet/IP adapter in the FLEX 5000 I/O system sends the data over the EtherNet/IP network.
3. One of the following occurs:
 - If the controller is directly connected to the EtherNet/IP network, it receives the input data from the network without need for a communication module.
 - If the controller is connected to the EtherNet/IP network through another communication module, the module transmits the data to its backplane and the controller receives it.

Listen Only Mode

Any controller in the system can listen to the data from an I/O module. An owner-controller, as described in [Ownership on page 22](#), exchanges data with digital I/O modules.

Other controllers can use a Listen Only connection with the digital I/O module. In this case, the 'listening' controller can only listen to input data or 'echoed' output data. The listening controller does not own the module configuration or exchange other data with the module.

During the I/O configuration process, you can specify a Listen Only connection. For more information on Connection options, see [Module Definition on page 94](#).

IMPORTANT Remember the following:

- The Listen Only Mode applies only to standard I/O modules.
- If a controller uses a Listen Only connection, the connection must use the Multicast option. In this case, all other connections to the module, for example, the connection of the owner-controller, must also use the Multicast option.
- If a controller attempts to use a Listen Only connection to a module but the owner-controller connection uses the Unicast option, the attempt at a Listen Only connection fails.

The 'Listen Only' controller receives data from the module as long as a connection between an owner-controller and module is maintained.

- If the connection between an owner-controller and the module is broken, the module stops sending data and connections to all 'listening controllers' are also broken.
-

Protected Operations

To maintain the secure operation of your FLEX 5000 digital I/O module, operations that can disrupt module operation are restricted based on the module operating mode. [Table 8](#) describes the restrictions.

Table 8 - Protected Operations on FLEX 5000 Digital I/O Modules

Current Module Operation	Activity						
	Firmware Update Request	Module Reset Request	Connection Request	Configuration Change	Connection or Data Format Change	Electronic Keying Change	RPI Change
Connection not running	Accepted						
Connection running	Rejected		Accepted ⁽¹⁾	Accepted ⁽²⁾	Not allowed ⁽³⁾		Accepted ⁽⁴⁾
Firmware update is in process	Rejected						

- (1) Only requests for Listen Only connections are accepted.
- (2) Configuration change is accepted in the following scenarios:
 - Changes are made in the Module Properties dialog box and you click Apply.
 - Changes are made in the Configuration tags and you send a Reconfigure Module MSG to the module.
- (3) The difference between Rejected and Not allowed is that rejected activities can be attempted in the Logix Designer application but do not take effect. The activities that are not allowed, that is, attempts to change the Connection or Data Format used, do not occur in the Logix Designer application. For example, if you attempt to reset a module that is connected to the owner-controller, the Logix Designer application executes the request and alerts you that it was rejected. If you attempt to change the data format on a module that is connected to an owner-controller, the Logix Designer application does not execute the attempted change. The application only alerts you that the change is not allowed. In the case, if the change is attempted online, the Module Definition dialog box field that changes the data format is disabled.
- (4) The change occurs after the connection is closed and reopened. You can close and reopen the connection in the following ways:
 - Change the project while it is offline and download the updated project before going online again.
 - Change the project while it is online and click Apply or OK in the Module Properties dialog box. In this case, a dialog box alerts you of the ramifications before the change is made.

Considerations Specific to Safety Modules

Safety Modules

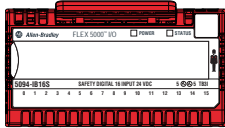

FLEX 5000 safety I/O modules have additional items to be aware of. Type approval, certification, and suitability for use in safety applications vary by catalog number.

These modules can be used with GuardLogix 5580 and Compact GuardLogix 5380 safety controllers in applications up to SIL 3, PLe, Cat. 4 in single-channel and dual-channel configurations. The Studio 5000 Logix Designer® application, version 32 or later, is the configuration and programming tool for these modules.

IMPORTANT TÜV Rheinland has approved GuardLogix 5580 and Compact GuardLogix 5380 controller systems for use in safety-related applications where the de-energized state is always considered to be the safe state. You must confirm that the configuration of each channel of the safety I/O module is set for “Off” under the Output State During Program Mode and Communications Fault Mode selection to consider those output points as part of the safety function of any equipment. The safety I/O modules to which this note applies include 1756-OBV8S, 5094-OB16S, and 5094-OW4IS.

IMPORTANT Functional safety certification and performance of FLEX 5000 I/O safety modules requires that the modules operate in conditions at or below the ambient operating temperature specification.

The Probability of Failure on Demand (PFD) and average frequency of a dangerous failure per hour (PFH) calculations for these modules are based on the module operating conditions adhering to the ambient operating temperature specification.

For more information on the maximum ambient operating temperature specification for FLEX 5000 I/O safety modules, see the FLEX 5000 Modules Specifications Technical Data, publication [5094-TD001](#).

These restrictions apply to the modules:

- Type-approved and certified for use in safety applications up to and including SIL 3 per IEC 61508
- Suitable for use in safety applications up to and including SIL CL 3 per IEC 62061
- Suitable for use in safety applications up to and including Performance Level e (PLe), category 4 per ISO 13849-1

IMPORTANT Requirements are based on the ISO standards that are current at the time of certification.

For more information on safety application suitability levels with the FLEX 5000 safety I/O modules, see the following:

- 5094-IB16S - Safety Input Module Features on [page 69](#)
- 5094-OB16S - Safety Output Module Features on [page 77](#)
- 5094-OW4IS - Safety Relay Output Module Features on [page 84](#)

Single-channel or Dual-channel Mode

You can use FLEX 5000 safety I/O modules in single-channel mode or dual-channel configuration. The configuration affects the safety application suitability level for a module.

In single-channel mode, the signal status on one channel is evaluated. Based on that status, safety input data and safety input status can be off or on.

In dual-channel mode, the consistency between the signal status on two channels is evaluated. Based on the status on both channels, safety input data and safety input status can be off or on.

You use safety instructions in the safety controller ladder logic with two single channels, that is, one even and one odd.

Use with Safety Controllers

Safety Modules

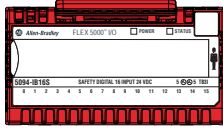

You can use only the Compact GuardLogix 5380 or GuardLogix 5580 controllers with the FLEX 5000 safety I/O modules. Restrictions apply with respect to how the controllers can use the I/O modules. The restrictions are described in Controller and Software Compatibility on page 14.

For more information on which controllers you can use with FLEX 5000 I/O safety modules, see [Table 2 on page 18](#).

You must use the Logix Designer application, version 32 or later, to configure the FLEX 5000 I/O safety modules.

Determine Conformity



ATTENTION: Use only appropriate components or devices that comply with the relevant safety standards and meet the required safety integrity level or performance level and safety category.

- Conformity to the requirements of the relevant safety standards must be determined for the entire system by conducting a risk assessment.
- Use devices properly according to the installation environment, performance rating, and functions of the machine.
- Use devices within their specified ratings.
- We recommend that you consult a certification body regarding assessment of conformity to the required safety integrity level or performance level.

You are responsible for confirming compliance with the applicable standards for the entire system. You must read, understand, and fulfill the functional safety requirements of the standard applicable to your safety application.

Obtain Firmware

Firmware information for safety I/O devices is available at the Rockwell Automation Product Compatibility and Download Center (PCDC). The PCDC is available at:

<https://compatibility.rockwellautomation.com/Pages/home.aspx>

Only download firmware and access product release notes from the Rockwell Automation PCDC.

Do not download firmware from non-Rockwell Automation sites.

Safety Function During Firmware Update

The FLEX 5000 I/O safety modules are not safety capable when a firmware update is in process. You must use other methods to maintain the safety function during the update process.

Safety Precautions



ATTENTION: Personnel responsible for the application of safety-related programmable electronic systems (PES) shall be aware of the safety requirements in the application of the system and shall be trained in the use of the system.

Observe these precautions for the proper use FLEX 5000 I/O safety modules.



ATTENTION: As serious injury can occur due to loss of required safety function, follow these safety precautions.

- Never use test outputs as safety outputs. Test outputs are not safety outputs.
 - Do not use standard I/O data or explicit message data as safety data.
 - Do not use light-emitting diode (LED) status indicators on the I/O modules for safety operations.
 - Do not connect loads beyond the rated value to the safety outputs.
 - Apply properly specified voltages to the module. Applying inappropriate voltages can cause the module to fail to perform its specified function, which could lead to loss of safety functions or damage to the module.
 - Wire the FLEX 5000 I/O safety modules as shown in the FLEX 5000 Technical Data, publication [5094-TD001](#).
 - Set unique network node addresses before connecting devices to the network.
 - Perform testing to confirm that device wiring, configuration, and operation is correct before starting system operation.
 - Do not disassemble, repair, or modify the module. This can result in loss of safety functions.
-

For more information about safety precautions, see [Secure Access to the System on page 19](#).

Installing and Replacing Modules



ATTENTION:

- Clear previous configuration data before connecting devices to the network or connecting input or output power to the device.
 - Configure the replacement device properly and confirm that it operates correctly.
 - After installation of the module, a safety administrator must confirm the installation and conduct trial operation and maintenance.
-

Safety Application Requirements

Safety application requirements include evaluating the following:

- Probability of failure rates (PFD and PFH)
- System reaction time settings
- Functional verification tests that fulfill appropriate safety-level criteria

Creating, recording, and verifying the safety signature is also a required part of the safety application development process. The safety controller creates the safety signatures. The safety signature consists of an identification number, date, and time that uniquely identifies the safety portion of a project. This number includes all safety logic, data, and safety I/O configuration.

For safety system requirements, including information on the safety network number (SNN), verifying the safety signature, functional verification test intervals, system reaction time, and PFD/PFH calculations, see the GuardLogix 5580 and Compact GuardLogix 5380 Controller Systems Safety Reference Manual, publication [1756-RM012](#).

You must read, understand, and fulfill the requirements that are described in this publication before you operate a safety system that uses FLEX 5000 I/O safety modules.

Safe State



ATTENTION:

- The safe state of the outputs is defined as the off state.
- The safe state of the module and its data is defined as the off state.
- Use the FLEX 5000 I/O safety modules only in applications where the off state is the safe state.

The following are the safe states of the safety modules:

- Safety outputs: OFF
- Safety input data to network: OFF

Figure 6 - Safety Status

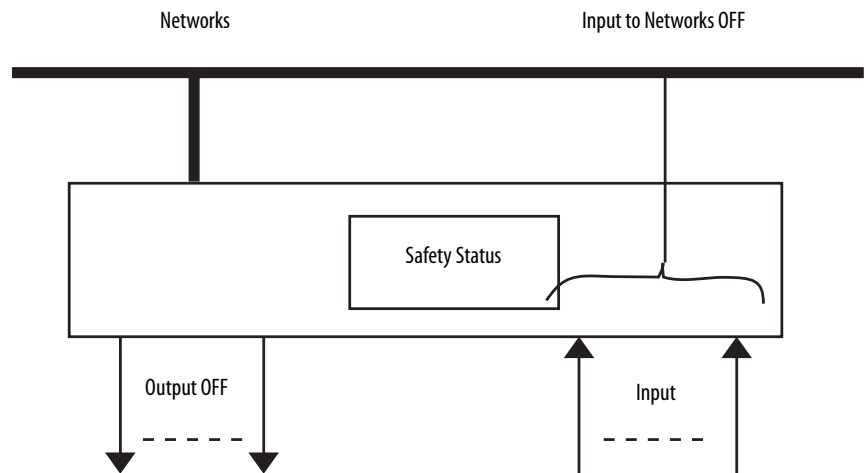

The modules are designed for use in applications where the safe state is the off state.

IMPORTANT If you inhibit a safety module from transitioning to a safe state when a fault occurs because an I/O connection is lost, you accept responsibility for any consequences that result from your decision to inhibit. We recommend that you use other means to maintain the safe state if you inhibit the safety module from transitioning to a safe state.

Configuration Signature and Ownership

Every FLEX 5000 I/O safety module in a system has a configuration signature and configuration ownership.

Configuration Signature

Each safety device has a unique configuration signature that defines the module configuration. The configuration signature includes the following:

- ID number
- Date
- Time

The configuration signature is used to verify a module's configuration.

IMPORTANT The signature can only be considered "verified" (and configuration locked) after user testing.

Configuration Ownership

The connection between the owner-controller and the FLEX 5000 I/O safety module is based on the following:

- FLEX 5000 I/O safety module node number
- FLEX 5000 I/O safety module safety network number
- Controller node or slot number

IMPORTANT If the owner-controller is a Compact GuardLogix 5380 controller, the controller has a node number.
If the owner-controller is a GuardLogix 5580 controller, the controller has a slot number.

- Controller safety network number
- Path from the controller to the FLEX 5000 I/O safety module
- Configuration signature

If any differences are detected, the connection between the owner-controller and the FLEX 5000 I/O safety module is lost, the yellow yield icon appears in the controller project tree.

Different Configuration Owner

When a controller owns the I/O module configuration, other controllers can listen to the input module. In this case, the module configuration signature in the Logix Designer project for any listening controller must match the one in the owner-controller project.

TIP If the safety module is configured for inputs only, you can copy and paste the configuration signature from one project to the other.

If the safety module has safety outputs, for example, the 5094-0B16S module, the configuration signature parameter is disabled.

Reset FLEX 5000 I/O Safety Modules to Out-of-Box State

If a FLEX 5000 I/O safety module was used previously, you must clear the configuration ownership before you can install it on a safety network. That is, you must return the module configuration to its out-of-box state.

When a FLEX 5000 I/O safety module is in the out-of-box state, its configuration is not owned by a controller.

The Safety category on the Module Properties dialog box displays the module Configuration Ownership. The Logix Designer application project must be online to check.

If the module configuration is owned, the Safety category displays whether the controller for the opened project owns the module configuration or another controller owns it.

For information on how to reset the module in the Logix Designer application, see [Reset to Out-of-Box Configuration on page 120](#).

You cannot reset the module to its out-of-box configuration if either of the following conditions is true:

- Pending edits to the module properties exist
- Safety signature exists in the controller project

Notes:

Common Digital I/O Module Features

Topic	Page
Input Module Compatibility	45
Output Module Capability	46
Producer/Consumer Communication	46
Module Data Quality Reporting	47
Software Configurable	48
Fault and Status Reporting	48
Module Firmware	48
Module Inhibiting	49
Electronic Keying	50

This chapter describes module features that are available on all FLEX 5000™ digital I/O modules.

Input Module Compatibility

Standard Modules

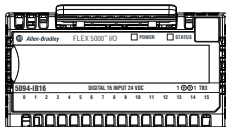

Safety Modules

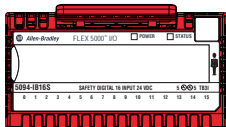

FLEX 5000 digital input modules interface to sensing devices and detect whether they are On or Off.

FLEX 5000 digital input modules convert DC On/Off signals from user devices to appropriate logic level for use within the processor. Typical input devices include the following:

- Proximity switches
- Limit switches
- Selector switches
- Float switches
- Push button switches

When you design systems with FLEX 5000 digital input modules, consider these factors:

- Voltage necessary for your application
- Current leakage
- Whether you need a solid-state device
- Whether your application uses sinking or sourcing wiring

Output Module Capability

Standard Modules

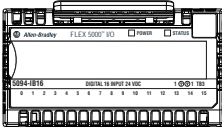

Safety Modules

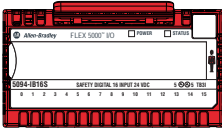

FLEX 5000 digital output modules can be used to drive various output devices. Typical output devices compatible with FLEX 5000 digital output modules include these items:

- Motor starters
- Solenoids
- Indicators

Follow these guidelines when designing a system:

- Make sure that the FLEX 5000 digital output modules can supply the necessary surge and continuous current for proper operation.
- Make sure that the surge and continuous current are not exceeded. Damage to the module could result.

When you size output loads, refer to the documentation supplied with the output device for the surge and continuous current necessary to operate the device.

Producer/Consumer Communication

Standard Modules

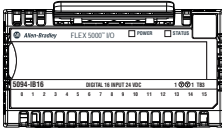

Safety Modules

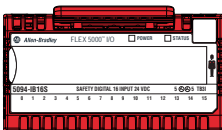

FLEX 5000 digital I/O modules use the Producer/Consumer communication model to produce data without a controller polling them first. The modules produce the data and controllers consume it. That is, the owner-controller and controllers with a Listen Only connection to the module can consume it.

When an input module produces data, the controllers can consume the data simultaneously. Simultaneous data consumption mitigates the need for one controller to send the data to other controllers.

Module Data Quality Reporting

Standard Modules

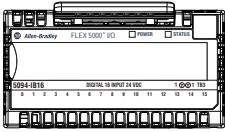

Safety Modules

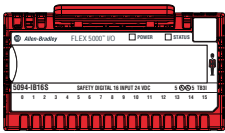

The FLEX 5000 digital I/O modules indicate the quality of point data that is returned to the owner-controller. Data quality represents accuracy. Levels of data quality are reported via module input tags.

The following inputs indicate the level of data quality.

IMPORTANT Once the condition that causes the Fault or Uncertain tag to change to 1 is removed, the tag automatically resets to 0. The Logix Designer application controls the tags. You cannot change the status of the tags.

Keep in mind that in some system configurations, the tag is not reset immediately after the condition is removed. The tag typically resets after a small delay.

- **I.Ptxx.Fault** - This tag indicates that the reported point data is inaccurate and cannot be trusted for use in your application. Do not use the reported channel data for control.

If the tag is set to 1, you cannot trust the data reported. You must troubleshoot the module to correct the cause of the inaccuracy.

Example causes of inaccurate data include the following:

- Field Power Loss condition (output modules)
- No Load condition (output modules)
- Short Circuit condition (output modules)

TIP We recommend that you troubleshoot the module for the typical causes first.

- **I.Ptxx.Uncertain** - This tag indicates that the reported point data can be inaccurate but the degree of inaccuracy is unknown. We recommend that you do not use the reported channel data for control.

If the tag is set to 1, you know that the data can be inaccurate. You must troubleshoot the module to discover what degree of inaccuracy exists.

Example causes of uncertain data include the following:

- Module is operating outside its designed operating range
- Data is under manual or override control

TIP We **strongly recommend** that you monitor the tags in your program to make sure that the application is operating as expected with accurate channel input data.

Software Configurable

Standard Modules

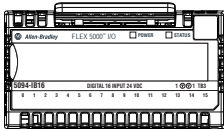

Safety Modules

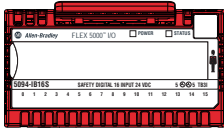

You use the Logix Designer application to configure the module, monitor system operation, and troubleshoot issues. You can also use the Logix Designer application to retrieve the following information from any module in the system:

- Serial number
- Firmware revision information
- Product code
- Vendor
- Error and fault information
- Diagnostic information

By minimizing the need for tasks, such as setting hardware switches and jumpers, the software makes module configuration easier and more reliable.

Fault and Status Reporting

Standard Modules

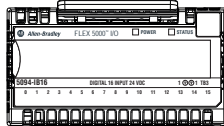

Safety Modules

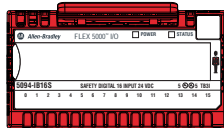

The FLEX 5000 digital I/O modules report fault and status data along with point data. Fault and status data is reported in the following ways:

- Logix Designer application
- Module status indicators

IMPORTANT Do not use the module status indicators or I/O status indicators on FLEX 5000 I/O safety modules for safety operations.

For more information on fault reporting, see the individual module feature chapters and [Appendix A, Troubleshoot Your Module on page 123](#).

Module Firmware

Standard Modules

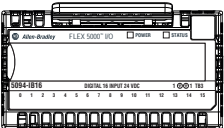

Safety Modules

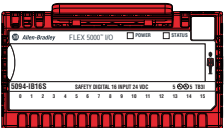

The FLEX 5000 digital I/O modules are manufactured with module firmware installed. If updated module firmware revisions are available in the future, you can update the firmware.

Updated firmware revisions are made available for various reasons, for example, to correct an anomaly that existed in previous module firmware revisions.

Firmware information for I/O devices is available at the Rockwell Automation Product Compatibility and Download Center (PCDC). The PCDC is available at: <https://compatibility.rockwellautomation.com/Pages/home.aspx>

At the PCDC, you can use the module catalog number to check for firmware updates. If the catalog number is not available, then no updates exist.

Verify that the firmware revision of the FLEX 5000 I/O modules that you use is correct before commissioning the system.

IMPORTANT Only download firmware and access product release notes from the Rockwell Automation PCDC.
Do not download firmware from non-Rockwell Automation sites.

Module Inhibiting

Standard Modules

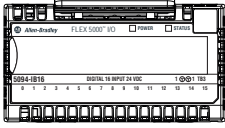

Safety Modules

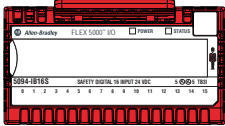

Module inhibiting lets you indefinitely suspend a connection, including Listen Only connections, between an owner-controller and a digital I/O module without removing the module from the configuration. This process lets you temporarily disable a module, such as to perform maintenance.

IMPORTANT You cannot inhibit a connection when the controller is safety-locked or a safety signature exists for the controller.

You can use module inhibiting in the following ways:

- You write a configuration for an I/O module but inhibit the module to help prevent it from communicating with the owner-controller. The owner does not establish a connection and the configuration is not sent to the module until the connection is uninhibited.
- In your application, a controller already owns a module, has downloaded the configuration to the module, and is exchanging data over the connection between the devices.

In this case, you can inhibit the module and the connection to the module does not exist.

IMPORTANT Whenever you inhibit an output module that is ProgMode enabled, it enters Program mode, and all outputs change to the state configured for Program mode.

For example, if an output module is configured so that the state of the outputs transition to zero during Program mode, whenever that module is inhibited, outputs transition to zero.

You can use module inhibiting in these instances:

- You want to update a digital I/O module, for example, update the module firmware revision. Use the following procedure.
 - a. Inhibit the module.
 - b. Perform the update.
 - c. Uninhibit the module.
- You use a program that includes a module that you do not physically possess yet. You do not want the controller to look for a module that does not yet exist. In this case, you can inhibit the module in your program until it physically resides in the proper slot.

To see where to inhibit a FLEX 5000 digital I/O module, see [page 120](#).

Electronic Keying

Standard Modules

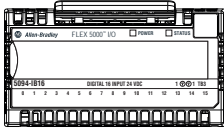

Safety Modules

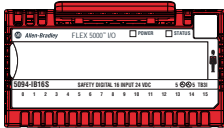

Electronic Keying reduces the possibility that you use the wrong device in a control system. It compares the device that is defined in your project to the installed device. If keying fails, a fault occurs. These attributes are compared.

Attribute	Description
Vendor	The device manufacturer.
Device Type	The general type of the product, for example, digital I/O module.
Product Code	The specific type of the product. The Product Code maps to a catalog number.
Major Revision	A number that represents the functional capabilities of a device.
Minor Revision	A number that represents behavior changes in the device.

The following Electronic Keying options are available.

Keying Option	Description
Compatible Module	<p>Lets the installed device accept the key of the device that is defined in the project when the installed device can emulate the defined device. With Compatible Module, you can typically replace a device with another device that has the following characteristics:</p> <ul style="list-style-type: none"> • Same catalog number • Same or higher Major Revision • Minor Revision as follows: <ul style="list-style-type: none"> – If the Major Revision is the same, the Minor Revision must be the same or higher. – If the Major Revision is higher, the Minor Revision can be any number. • Non-XT and XT version as follows: <ul style="list-style-type: none"> – You can use an XT version of the module in place of a non-XT module. – You cannot use a non-XT version of the module in place of an XT module.
Disable Keying	<p>Indicates that the keying attributes are not considered when attempting to communicate with a device. With Disable Keying, communication can occur with a device other than the type specified in the project.</p> <p>IMPORTANT: This option is not available for Safety applications.</p> <p>ATTENTION: Be extremely cautious when using Disable Keying; if used incorrectly, this option can lead to personal injury or death, property damage, or economic loss.</p> <p>We strongly recommend that you do not use Disable Keying.</p> <p>If you use Disable Keying, you must take full responsibility for understanding whether the device being used can fulfill the functional requirements of the application.</p>
Exact Match	<p>Indicates that all keying attributes must match to establish communication. If any attribute does not match precisely, communication with the device does not occur.</p>

Carefully consider the implications of each keying option when selecting one.

IMPORTANT Changing Electronic Keying parameters online interrupts connections to the device and any devices that are connected through the device. Connections from other controllers can also be broken.

If an I/O connection to a device is interrupted, the result can be a loss of data.

For more detailed information on Electronic Keying, see Electronic Keying in Logix5000 Control Systems Application Technique, publication [LOGIX-AT001](#).

Input Module Features

Topic	Page
Data Transfer at RPI	51
Software Configurable Input Filters and Delays	52
Field Power Loss Detection	52
Fault and Status Reporting	53

This chapter describes features common to these FLEX 5000™ standard and safety input modules:

- 16-point sinking **standard** input module, catalog number 5094-IB16
- 16-point sinking **standard** input module **for extreme environments**, catalog number 5094-IB16XT
- 16-point sinking **safety** input module, catalog number 5094-IB16S
- 16-point sinking **safety** input module **for extreme environments**, catalog number 5094-IB16SXT

Data Transfer at RPI

Standard Modules

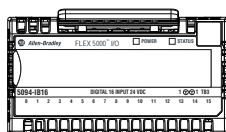

Safety Modules

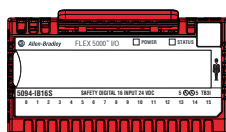

FLEX 5000 digital input modules always send data at the RPI, a user-defined rate at which the module updates the information sent to its owner-controller.

To see where to set the RPI for standard modules, see [page 26](#), and for safety modules, see [page 114](#).

Software Configurable Input Filters and Delays

Standard Modules

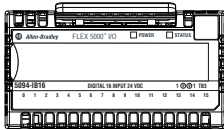

Safety Modules

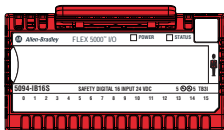

You can adjust On to Off and Off to On filter times through the Logix Designer application for all FLEX 5000 digital input modules. These filters improve noise immunity within a signal.

A larger filter value affects the length of delay times for signals from these modules. The filter values are adjustable in the Points category of the Module Properties window.

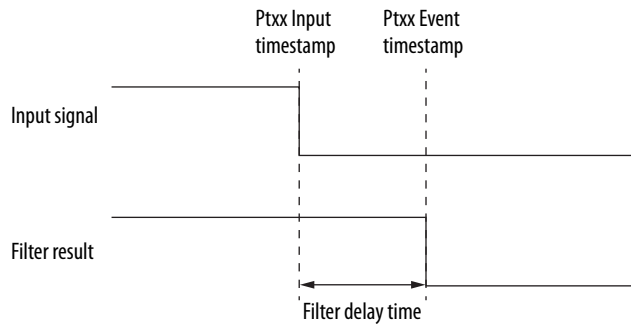

The input filter/delay values of the 5094-IB16/5094-IB16S and 5094-IB16XT/5094-IB16SXT input modules range from 0 μ s...50 ms.

To see where to set the input filter values for standard modules, see [page 97](#). To see where to set the input delay values for safety modules, see [page 115](#).

Field Power Loss Detection

Standard Modules

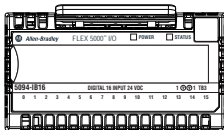

Safety Modules

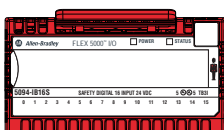

The Field Power Loss Detection feature monitors for the loss of power at an input module point. When field power to the module is lost, a point-level fault is sent to the controller to identify the exact point faulted.

Field Power Loss Detection has a corresponding tag that can be examined in the user program if a fault occurs. For information on modules, see [Appendix B, Module Tag Definitions on page 139](#)

To see where to enable or disable field power detection, see [page 97](#).

Fault and Status Reporting

Standard Modules

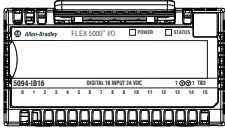

Safety Modules



The digital input modules multicast fault and status data with point data to the owner and listening controllers. The data is returned via modules that you can monitor in your Logix Designer application.

With some exceptions, the FLEX 5000 digital input modules provide the fault and data status in a point-centric format. The tag names in the following table that include Ptxx represent point-centric data. The xx represents the point number.

For more information on fault reporting, see [Appendix A, Troubleshoot Your Module on page 123](#).

Table 9 - FLEX 5000 Digital Input Module - Fault and Data Status

Data Type	Tag Name ⁽¹⁾	Triggering Event That Sets the Tag
Fault	ConnectionFaulted ⁽²⁾	The owner-controller loses its connection to the module.
	Ptxx.Fault	The point data quality is bad.
Status	RunMode	The module is in Run Mode.
	DiagnosticActive	Indicates if any diagnostics are active.
	DiagnosticSequenceCount	A counter that increments when a diagnostic condition occurs or goes away. The counter is a rolling counter that skips 0 on rollovers.
	Ptxx.Data	The point input status is one or zero.
	Ptxx.Uncertain	The point data can be imperfect.
	Uncertain	The module is operating outside its designed operating range if data is under manual or override control.

(1) Not all tag names apply to all FLEX 5000 digital input modules.

(2) This tag provides module-wide data and affects all points simultaneously.

Notes:

Output Module Features

Topic	Page
Features Specific to All FLEX 5000 Output Modules	56
Features Specific to Only Standard and Safety Solid-state Output Modules	61
Features Specific to Only Standard Output Modules	64
Feature Specific to Only Relay Output Modules	67

This chapter describes features common to these FLEX 5000™ standard and safety output modules:

- 16-point **standard** DC output module, catalog number 5094-OB16
- 16-point **standard** DC output module **for extreme environments**, catalog number 5094-OB16XT
- 16-point **safety** DC output module, catalog number 5094-OB16S
- 16-point **safety** DC output module **for extreme environments**, catalog number 5094-OB16SXT
- 4-point **safety** relay output module, catalog number 5094-OW4IS
- 4-point **safety** relay output module **for extreme environments**, catalog number 5094-OW4ISXT
- 8-point **standard** relay output module, catalog number 5094-OW8I
- 8-point **standard** relay output module **for extreme environments**, catalog number 5094-OW8IXT

Features Specific to All FLEX 5000 Output Modules

Standard Modules

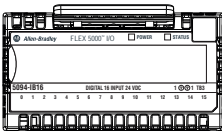

Safety Modules

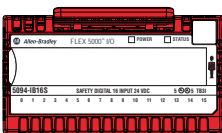

The following topics are specific to all FLEX 5000 output modules.

Output State Change Time

[Table 10](#) lists the time that it takes for FLEX 5000 output module outputs to change state after a command.

Table 10 - Time for a Module Output to Change States

Module	Time ⁽¹⁾
5094-OB16, 5094-OB16XT	100 μs
5094-OB16S, 5094-OB16SXT	4.5 ms
5094-OW8I, 5094-OW8IXT	10 ms
5094-OW4IS, 5094-OW4ISXT	20 ms (Off to On) 10 ms (On to Off) ⁽²⁾

(1) The times that are listed in [Table 10](#) are from the time the module receives the message.

(2) Under no fault condition.

Configurable Point-level Output State in Program Mode or Communications Fault Mode

You can configure individual output points to specific states when the module is in Program mode or Communications Fault mode. The following output states are available:

- Off
- On (This option is not available for Safety applications.)
- Hold last state

To see where to configure the output states in Program mode or Communications Fault mode, see the following:

- 5094-OB16 and 5094-OB16XT modules - [page 103](#)
- 5094-OB16S and 5094-OB16SXT modules - [page 117](#)
- 5094-OW4IS and 5094-OW4ISXT modules - [page 117](#)
- 5094-OW8I and 5094-OW8IXT modules - [page 104](#)

Safety Modules

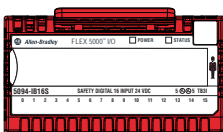

ATTENTION: Selection of “Hold” for Output State During Program mode and Communications Fault mode prevents the output point from going to the safe state, making the output point not suitable for a SIL or PL rated safety function.

Set Output State During Program mode and Communications Fault mode to “Off” to allow points to go to safe state.

Connection Fault Handling

You can configure FLEX 5000 output module behavior when a connection fault occurs, that is, the connection between the owner-controller and the output module breaks.

You must define the following:

- In standard and safety modules
 - Immediate output behavior when the connection breaks
- In standard modules only
 - Length of time that the output behaves as defined
 - Output behavior if the connection remains broken when the length of time that is defined previously expires

Output Behavior Immediately After a Connection Fault

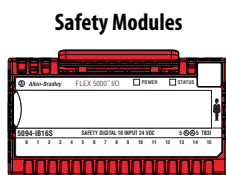

ATTENTION: Selection of “Hold” for Output State During Program mode and Communications Fault mode prevents the output point from going to the safe state, making the output point not suitable for a SIL or PL rated safety function.

Set Output State During Program mode and Communications Fault mode to “Off” to allow points to go to safe state.

When the connection between an owner-controller and output module breaks, the output can behave in the following ways, depending on how the Communications Fault mode parameter is configured:

- Turn off - Default
- Transition to a specific, user-defined value
(This option is not available for Safety applications.)
- Hold its last state

The output remains at that state value until the following occurs:

- The connection to the owner-controller is re-established.
- The output returns to normal operation, as defined in the module configuration.

Output State Once Connection Is Re-established

Once the connection between the owner-controller and output module is re-established, the output resumes normal operation.

To see where to configure the Connection Fault Handling parameters, see the following:

- 5094-OB16 and 5094-OB16XT modules - [page 103](#)
- 5094-OB16S and 5094-OB16SXT modules - [page 117](#)
- 5094-OW4IS and 5094-OW4ISXT modules - [page 117](#)
- 5094-OW8I and 5094-OW8IXT modules - [page 104](#)

Forcing

Use a force to override data that your logic either uses or produces.

- Test and debug your logic.
- Temporarily maintain normal system operations when an input device has failed.

Use forces only as a temporary measure. They are not intended to be a permanent part of your application.

Make sure that you understand the following before using forces.



ATTENTION: Forcing can cause unexpected machine motion that could injure personnel. Before you use a force, determine how the force affects your machine or process and keep personnel away from the machine area.

- Enabling I/O or SFC forces causes your machine or process to go to another state or phase.
 - Removing forces can still leave forces in the enabled state.
 - If forces are enabled and you install a force, the new force immediately takes effect.
-

Enable Forces

For a force to take effect, you enable forces. You can only enable and disable forces at the controller level.

- You can enable I/O forces and SFC forces separately or simultaneously.
- You cannot enable or disable forces for a specific module, tag collection, or tag element.

Disable or Remove a Force

To stop the effect of a force and let your project execute as programmed, disable or remove the force.

- You can disable or remove I/O and SFC forces simultaneously or separately.
- When you remove a force on an alias tag, you also remove the force on the base tag.



ATTENTION: Changes to forces can cause unexpected machine motion that could injure personnel. Before you disable or remove forces, determine how the change affects your machine or process and keep personnel away from the machine area.

Check Force Status

Before you use a force, determine the status of forces for the controller.

The Online toolbar shows the status of forces. It shows the status of I/O forces and SFC forces separately.

To determine the status of	Use any of the following
I/O forces	<ul style="list-style-type: none"> • Online toolbar • GSV instruction
SFC forces	Online toolbar



Forces tab

Forces Tab Status	Means
Enabled	<ul style="list-style-type: none"> • If the project contains any forces of this type, they are overriding your logic. • If you add a force of this type, the new force immediately takes effect
Disabled	Forces of this type are inactive. If the project contains any forces of this type, they are not overriding your logic.
Installed	At least one force of this type exists in the project.
None Installed	No forces of this type exist in the project.

GSV Instruction

This example shows how to use a GSV instruction to get the status of forces. For the purposes of this example, Force_Status is a DINT tag.

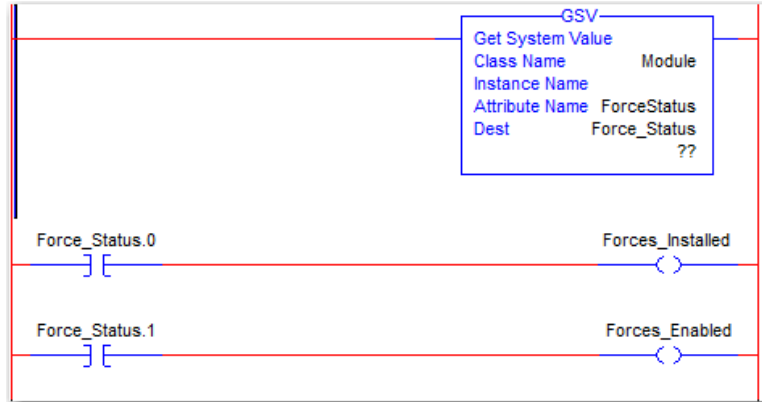

Table 11 - GSV Instruction

To determine the following	Examine this bit	For this value
Forces are installed	0	1
No forces are installed	0	0
Forces are enabled	1	1
Forces are disabled	1	0

Data Echo

Data Echo automatically multicasts point data values that match the digital value that was sent to the screw terminals of the module then.

A FLEX 5000 digital output module returns a value sent to it by the owner-controller. The echoed value is either On or Off.

Fault and status data are also sent. This data is sent at the RPI.

Field Power Loss Detection

The Field Power Loss Detection feature monitors for the loss of power at an output module point. When field power to the module is lost, a point-level fault is sent to the controller to identify the exact point faulted.

Field Power Loss Detection has a corresponding tag that can be examined in the user program if a fault occurs. For information on modules, see [Appendix B, Module Tag Definitions on page 139](#)

Fault and Status Reporting

The digital output modules multicast fault and status data with point data to the owner and listening controllers. The data is returned via modules that you can monitor in your Logix Designer application.

IMPORTANT For 5094-OB16 and 5094-OB16XT output modules only, an output must remain in the On state for a minimum of 250 ms for an overload or short circuit to be detected. However, if a short-circuit condition exists long term, it is detected as long as the output is switching at a rate no faster than 1 ms.

For more information on fault reporting, see [Appendix A, Troubleshoot Your Module on page 123](#).

Table 12 - FLEX 5000 Digital Output Module - Fault and Data Status

Data Type	Tag Name ⁽¹⁾	Triggering Event That Sets the Tag
Fault	Connection Faulted ⁽²⁾	The owner-controller loses its connection to the module.
	Ptxx.Fault	The point data quality is bad.
	Ptxx.NoLoad	A no load condition exists on the point.
	Ptxx.ShortCircuit	A short-circuit condition exists on the point.
Status	RunMode	The module is in Run Mode.
	DiagnosticActive	Indicates if any diagnostics are active.
	DiagnosticSequenceCount	A counter that increments when a diagnostic condition occurs or goes away. The counter is a rolling counter that skips 0 on rollovers.
	Ptxx.Data	The point data is one or zero.
	Ptxx.Uncertain	The point data can be imperfect.
	Uncertain	The module is operating outside its designed operating range if data is under manual or override control.

(1) Not all tag names apply to all FLEX 5000 tag.digital I/O modules.

(2) This tag provides module-wide data and affects all points simultaneously.

Features Specific to Only Standard and Safety Solid-state Output Modules

The following features are specific to only the standard and safety solid-state output modules, catalog numbers 5094-OB16, 5094-OB16XT, 5094-OB16S, and 5094-OB16SXT.

No Load Detection

No Load Detection detects when a wire is disconnected from the output or a missing load for each output point.

For standard modules, No Load Detection occurs only when the output point is in the Off state. For safety modules, No Load Detection occurs when the output points are in either state, Off or On.

For standard modules, the No Load Detection feature is disabled by default. You must enable the feature in your Logix Designer application project. For safety modules, the No Load Detection feature is always enabled; it is not configurable.

IMPORTANT These FLEX 5000 output modules are the only ones to support No Load Detection:

- 5094-OB16
- 5094-OB16XT
- 5094-OB16S
- 5094-OB16SXT

The standard output modules support the following minimum load currents:

- No load detection current, max = 0.5 mA
- On-state current per point, max = 1 mA

The I.Ptxx.NoLoad tag indicates the presence of a no load condition when it is set to 1.

You can monitor a module tag in your program that corresponds to the No Load Detection to check for a fault. For more information on the tag, see [Appendix B, Module Tag Definitions on page 139](#).

For safety output modules (5094-OB16S and 5094-OB16SXT), the guaranteed load detection is 10 mA for both states, Off and On.

Recommended Loading Resistor - To limit the effects of leakage current through solid-state outputs, you can connect a loading resistor in parallel with your load. For 24V DC operation in standard modules, use a 5.6K ohms, 0.5 W resistor for transistor operation. For 24V DC operation in safety modules, use a 2.4K ohms, 0.5 W resistor for transistor operation.

In the On state, the module must be connected to a load that draws a minimum current equal to these values.

IMPORTANT An output must remain in the off state a minimum of 250 ms for an open load to be detected.

Short-Circuit Protection

Short-Circuit Protection helps prevent damage to the output that can result when more current is present at the output than it can handle.

For safety output modules (5094-OB16S and 5094-OB16SXT), I.Ptxx.ShortCircuit tag is used for short to high or channel to channel shorts, which do not incur over current.

There are ShortCircuitGround and Overload tags in Diagnostic assembly.

IMPORTANT	These FLEX 5000 output modules are the only ones to support the Short-Circuit Detection feature: <ul style="list-style-type: none">• 5094-OB16• 5094-OB16XT• 5094-OB16S• 5094-OB16SXT
------------------	--

In standard modules, when a short-circuit condition is detected, the following occurs:

- The output turns off.
- The I/O status indicator for the output becomes steady red.
- The I.Ptxx.ShortCircuit tag is set to 1.

For more information on how to use the modules, see [Appendix B, Module Tag Definitions on page 139](#).

In standard modules, when the short-circuit condition is removed, the following occurs:

- The output restarts in its commanded state.
- The I/O status indicator for the output turns off.
- The I.Ptxx.ShortCircuit tag is reset to 0.

For safety modules, refer to the [Safety Output Fault Reset](#) procedure on [page 83](#).

For more information on the maximum current that you can apply to an output, see the FLEX 5000 Modules Specifications Technical Data, publication [5094-TD001](#).

Thermal Shutoff

Thermal Shutoff helps prevent damage to the output that can result when an output gets hotter than it can handle.

IMPORTANT	These FLEX 5000 digital output modules are the only ones to support the Thermal Shutoff feature: <ul style="list-style-type: none">• 5094-OB16• 5094-OB16XT• 5094-OB16S• 5094-OB16SXT
------------------	--

This feature is **directly related to Short-Circuit Protection** feature. The increased temperature at the output results from an excessive load at the output.

That is, a load with high current is applied to the output. The high current heats the output beyond an acceptable temperature and the output turns off.

In the safety output modules (5094-OB16S, 509-OB16SXT), if overload or short circuit to ground occurs, the point will turn off. This trigger by current threshold is exceeded, regardless of temperature.

For standard modules, when conditions exist that cause Thermal Shutoff to turn off the output, the following occurs:

- The output turns off.
- The I/O status indicator for the output becomes solid red.
- The I.Ptxx.ShortCircuit tag is set to 1.

For more information on how to use the modules, see [Appendix B, Module Tag Definitions on page 139](#).

For standard modules, when the conditions that caused a Thermal Shutoff no longer exist, the following occurs:

- The output restarts in its commanded state.
- The I/O status indicator for the output turns off.
- The I.Ptxx.ShortCircuit tag is reset to 0.

For safety modules, refer to the [Safety Output Fault Reset](#) procedure on [page 83](#).

Features Specific to Only Standard Output Modules

Standard Modules

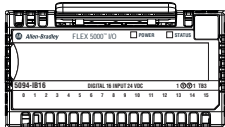

The following features are specific to only the 5094-OB16 and 5094-OB16XT modules.

Time-scheduled Output Control

You can schedule times for module outputs to turn On or Off. The time schedules use units in nanoseconds.

IMPORTANT These FLEX 5000 standard output modules are the only ones to support the Time-scheduled Output Control feature:

- 5094-OB16
- 5094-OB16XT

The timing of scheduled outputs for the 5094-OB16 and 5094-OB16XT modules are as follows:

- ±100 μs accuracy
- 1 ns resolution

The module must be time synced or schedules are note applied.

Time-scheduled output control is used with the Motion Arm Output Cam (MAOC) instruction. The MAOC instruction enables position-based output control in these ways:

- Uses the position of any motion axis in a Logix 5000™ control system as the position reference
- Updates the outputs based on the motion axis position at the motion group coarse update rate, typically 1...32 ms.

The instruction can update standard digital output modules at the coarse update rate. However, some high-speed applications require a higher degree of accuracy.

The scheduled output modules improve the accuracy of the MAOC instruction by supporting the ability to schedule output On and Off times. All scheduling configuration for the On and Off times of an output is completed through the MAOC instruction. The instruction then updates values in the outputs of the module that define the scheduled output behavior.

Table 13 - FLEX 5000 Output Module Schedule Parameters

Feature	5094-OB16, 5094-OB16XT
Number of schedules	32
Output points available for scheduling	16 (points 0...15)
Remote operation	N/A
Minimum schedule interval ⁽¹⁾	100 µs For schedules output the MAOC instruction, you can use 50 µs.

(1) The MAOC limits the minimum schedule interval (minimum pulse width) to 1/16 of the coarse update period.

Use a MAOC Instruction with a 5094-OB16 or 5094-OB16XT Standard Output Module

To use a MAOC instruction with schedule outputs on a 5094-OB16 or 5094-OB16XT output module, complete the following steps.

IMPORTANT Before you complete the steps, make sure that Time Synchronization is enabled in the controller and, if applicable, the Ethernet module, to use scheduled outputs.

1. If necessary, add a 5094-OB16 or 5094-OB16XT output module to your Logix Designer application project.

For more information on how to add a 5094-OB16 or 5094-OB16XT output module to a Logix Designer application and configure the module, see [Chapter 6, Configure the Standard Module on page 87](#).

- From the Module Properties dialog box, click Change to access the Module Definition parameters.

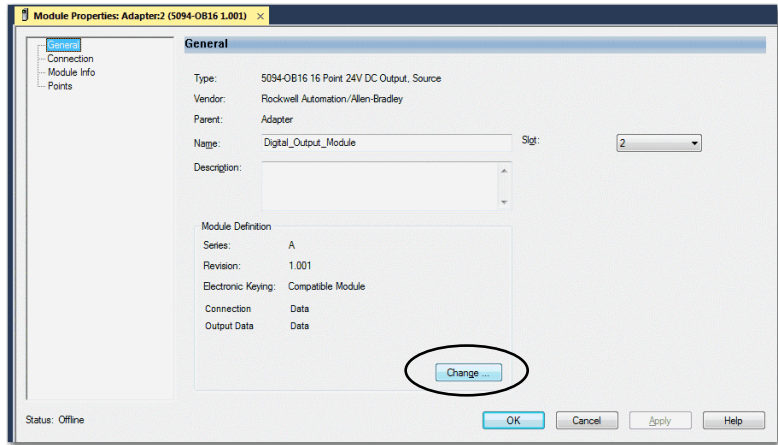

- On the Module Definition dialog box, choose Scheduled Data for the Output Data and click OK.

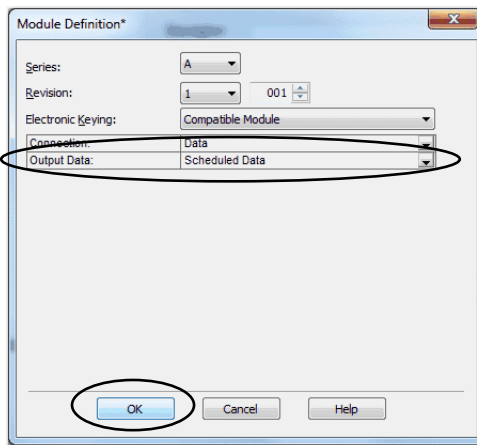

- Click OK to close the Module Properties dialog box.
- Add an MAOC instruction to your logic.
- In the MAOC instruction, use the module output tag in the Output operand, for example **Adapter: 1:O** for the output module and shown below.

The tag value displays as ???. This value is correct.

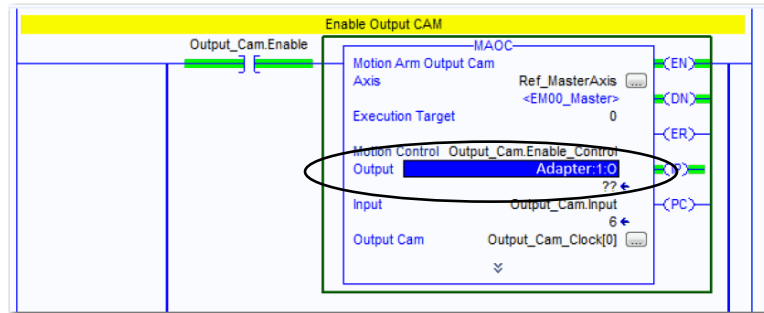

For more information on how to use an MAOC instruction in general, see the following:

- Logix5000 Controllers Motion Instructions Reference Manual, publication [MOTION-RM002](#)
- Position-based Output Control with the MAOC Instruction Application Technique, publication [1756-AT017](#)

Feature Specific to Only Relay Output Modules

Standard Modules

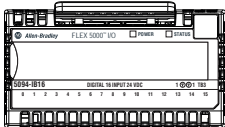

Safety Modules

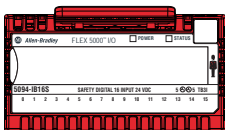

The following feature is specific to only the relay output modules.

Isolated Output

These digital output modules provide point-to-point wiring isolation:

- 5094-OW4IS
- 5094-OW4ISXT
- 5094-OW8I
- 5094-OW8IXT

IMPORTANT Although some FLEX 5000 digital I/O modules do not provide wiring isolation, all FLEX 5000 modules maintain internal electrical isolation between the system-side and field-side power buses.

Notes:

Safety I/O Module Features

Safety Modules

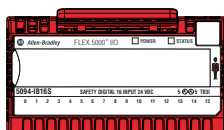

Topic	Page
Safety Input Module Features	69
Safety Output Module Features	77
Safety Relay Output Module Features	84
Fault and Status Reporting	85

This chapter describes features that are specific to FLEX 5000™ I/O safety modules.

Safety Input Module Features

This section describes features that are available on the FLEX 5000 I/O safety input modules, that is, the 5094-IB16S and 5094-IB16SXT modules.

The 5094-IB16S and 5094-IB16SXT modules are 16-point safety sinking input modules that use 16 safety inputs and 8 test outputs.

Safety Application Suitability Levels

[Table 14](#) describes the safety application suitability levels for a 5094-IB16S and 5094-IB16SXT module.

Table 14 - Safety Application Suitability for 5094-IB16S and 5094-IB16SXT Modules

Suitability Level	Conditions	Notes
Applications that are rated up to, and including, SIL CL3, PLc, Cat.2, as defined in IEC 61508, IEC 61551, IEC 62061, and ISO 13849-1	The modules uses single-channel mode <ul style="list-style-type: none"> – Point mode is Safety Pulse Test or Safety 	Consider the following: <ul style="list-style-type: none"> • The channel mode type, that is, single or dual, affects Performance Level and Category. You can use the modules in SIL CL3 applications regardless of channel mode type. • To achieve SIL CL3 single-channel, the sensor that is used must be SIL CL3 single-channel as well. • The requirement that Point mode be Safety Pulse Test assumes that only the safety I/O module provides diagnostics to a specific Suitability Level. The larger safety system within which the safety I/O module resides can provide the diagnostics necessary to achieve the stated Suitability Level without the requirement that Point mode be Safety Pulse Test. To achieve the specific Safety Integrity Level, see Appendix C, Application/Wiring Examples for Safety I/O Modules on page 159.
Applications that are rated up to, and including, SIL CL3, PLc, Cat.4, as defined in IEC 61508, IEC 61551, IEC 62061, and ISO 13849-1	<ol style="list-style-type: none"> 1. The modules use single-channel mode: <ul style="list-style-type: none"> – Point mode is Safety Pulse Test or Safety – Use sheathed cable or cable trunk to separate channel wiring to mitigate short-circuit faults. 2. The modules use dual-channel mode: <ul style="list-style-type: none"> – Point mode is Safety – Use sheathed cable or cable trunk to separate channel wiring to mitigate short-circuit faults. 3. The modules use dual-channel mode: <ul style="list-style-type: none"> – Point mode is Safety Pulse Test only 	

Input Modules in CIP Safety Systems

The following apply to the **safety inputs**:

- You can connect safety devices, such as Emergency Stop Push Button, gate switches, and safety light curtains.
- An external wiring short-circuit check is possible when inputs are wired in combination with test outputs. The module must be wired in combination with test outputs when this function is used.
- Independently adjustable on and off delays are available per channel.
- If you configure test outputs, you must choose a test source.
- Diagnostics. See [Point Diagnostics](#).
- Safety input points are configured as the following:
 - Not Used
 - Safety
 - Safety Pulse Test

The following apply to the **test outputs**:

- Test outputs can be configured as the following:
 - Not Used
 - Power Supply
 - Pulse Test
- Separate test outputs are provided for short-circuit detection of a safety input (or inputs).
- Can supply 24V DC power to devices, such as safety sensors.
- Test output rating (TO) 200 mA @ 18...32V DC

Use Test Output with a Safety Input

A test output can be used in combination with a safety input for short circuit and cross-channel fault detection.

Configure the test output as a pulse test source and associate it to a specific safety input. The associated safety input must use a Point Mode = Safety Pulse Test.

These mappings are the only allowed and default digital-input-to-test-output association mappings for Safety Pulse Test configuration. Only a test output that is configured as Pulse Test can be used as test source.

Safety Input	Maps to Test Output
0,8	0
1,9	1
2,10	2
3,11	3
4,12	4
5,13	5
6,14	6
7,15	7

Figure 7 - FLEX 5000 I/O Safety Input Module - Input Connected to Test Output

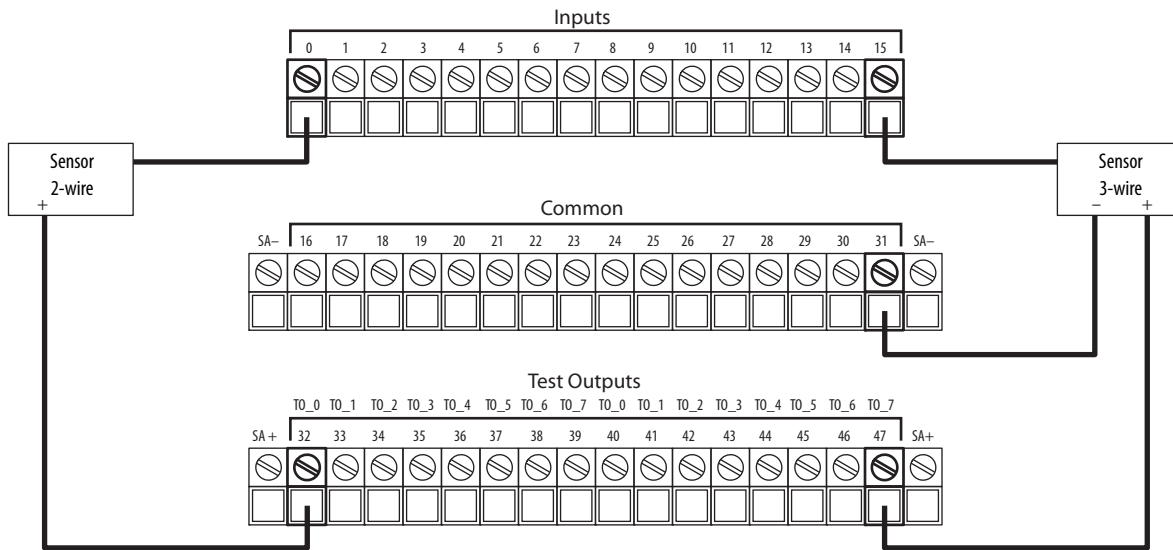

This diagram shows:

- A 2-wire sensor is connected to safety input 0, with test output 0 configured as Test Pulse/Power Supply.
- A 3-wire sensor is connected to safety input 15, with test output 7 configured as Power Supply.

Figure 8 - 5094-IB16S and 5094-IB16SXT Test Pulse in a Cycle

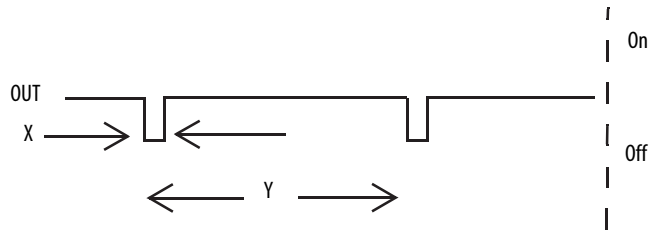

On the 5094-IB16S and 5094-IB16SXT modules, the pulse width (X) is less than 600 μ s; the pulse period (Y) is less than 100 ms.

When the external input contact is closed, a test pulse is output from the test output terminal to diagnose the field wiring and input circuitry. By using this function, short circuits between inputs and 24V power and between input signal lines can be detected. However, a short circuit between two input channels cannot be detected if these two channels correspond to the same Test Output. For example, Test Output 0 associates to Safety Input 0 and 8. If these two channels short circuit, it cannot be detected.

Figure 9 - Short Circuit Between Input Signal Lines

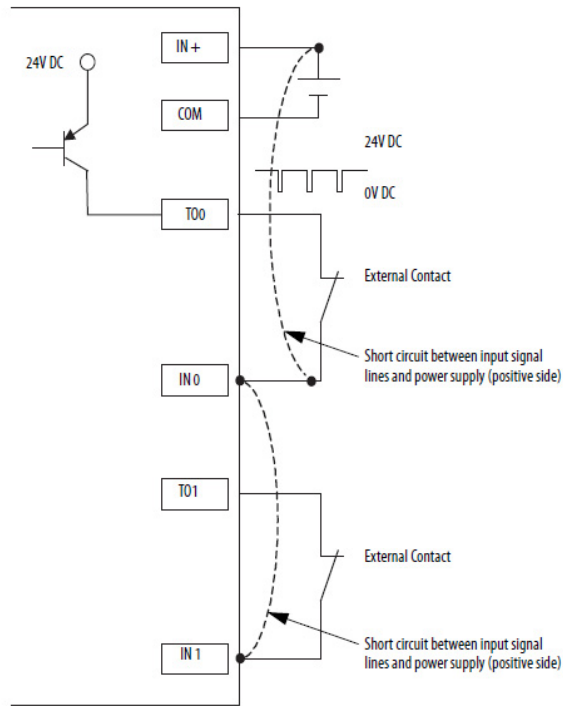

Single-channel Mode

If an error is detected on the input channel, Safety Input Data and Safety Input Status turn off.

For information about how using Single-channel mode with a 5094-IB16S or 5094-IB16SXT module affects the safety application suitability level, see [Table 14 on page 69](#).

Figure 10 - Normal Operation and Fault Detection (Not to Scale)

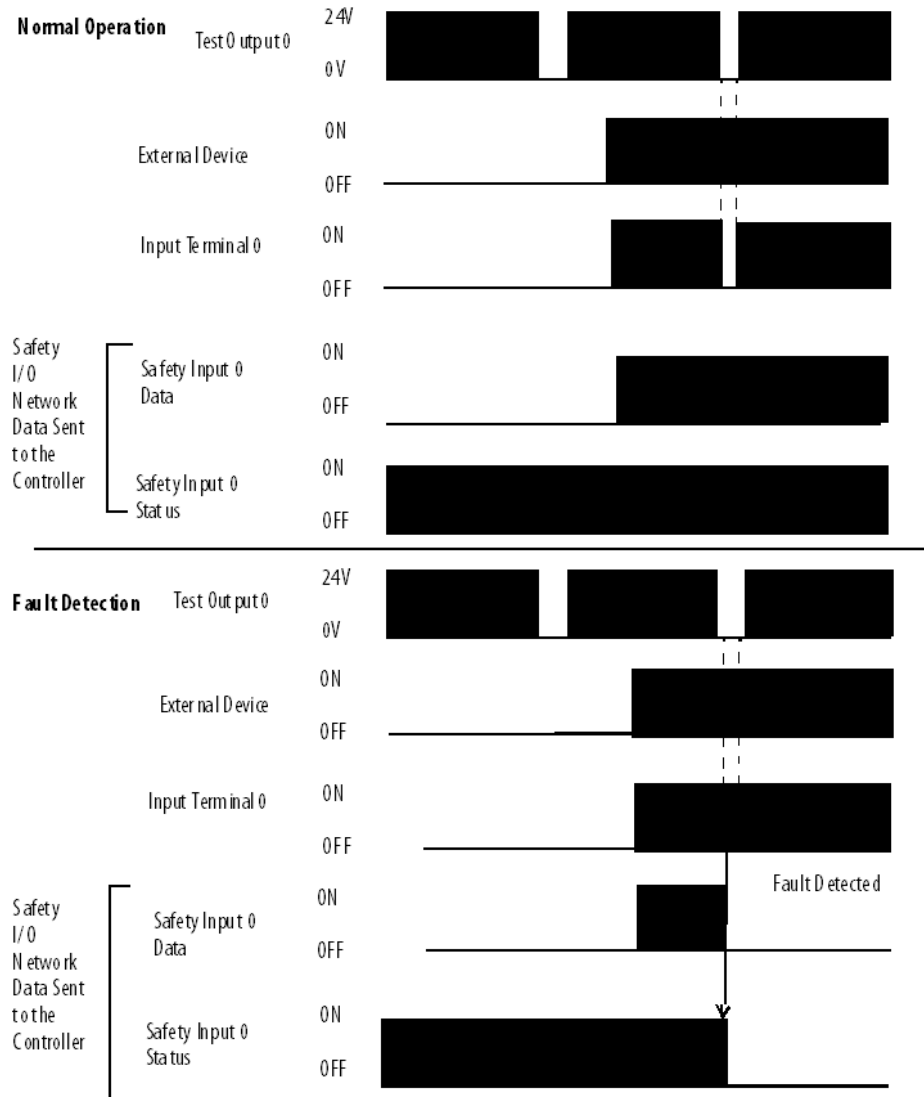

Safety Input Fault Reset

The I/O channel supports a module-level user-configurable 'Latch Fault until reset via output tag' mode and recovers from these faults:

- Field Power Off Detection
- Safety Input Short Circuit

'Latch Fault until reset via output tag' mode is Enabled.

When Latch Fault... mode is Enabled, the I/O channel holds safety input fault indications until it checks that the fault is removed. If the fault is removed, the channel clears the fault status only upon detecting that the ResetFault in its consume assembly channel sees a rising edge.

'Latch Fault until reset via output tag' mode is Disabled.

When Latch Fault... mode is Disabled (default), the I/O channel holds safety input fault indications for 1 second until it checks if the fault is removed. If the fault is removed, the channel clears the fault status only upon detecting the safety input is low on the screw. If not, the channel continues to check if the fault is removed.

Safety Input Delay

This setting helps prevent rapid changes of input data due to contact bounce.

Off to On Delay

An input signal is treated as Logic 0 during the Off to On delay time after the rising edge of the input contact.

The input turns on only if the input contact remains on after the Off to On delay time has elapsed. This setting help prevent rapid changes of the input data due to contact bounce.

You can delay the Off to On transition by the following times:

- 0 ms
- 1 ms
- 2 ms
- 5 ms
- 10 ms
- 20 ms
- 50 ms

Figure 11 - Off to On Delay

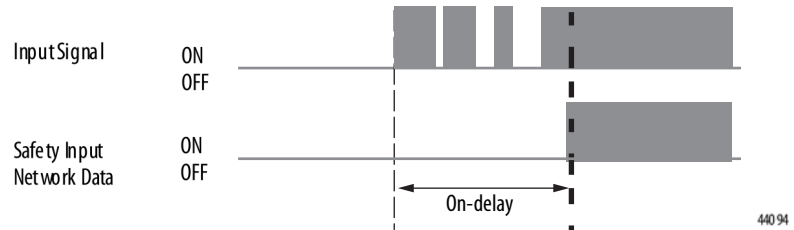

On to Off Delay

An input signal is treated as Logic 1 during the On to Off delay time after the falling edge of the input contact.

The input turns off only if the input contact remains off after the On to Off delay time has elapsed. This setting helps to prevent rapid changes of the input data due to contact bounce.

You can delay the On to Off transition by the following times:

- 0 ms
- 1 ms
- 2 ms
- 5 ms
- 10 ms
- 20 ms
- 50 ms

Figure 12 - On to Off Delay

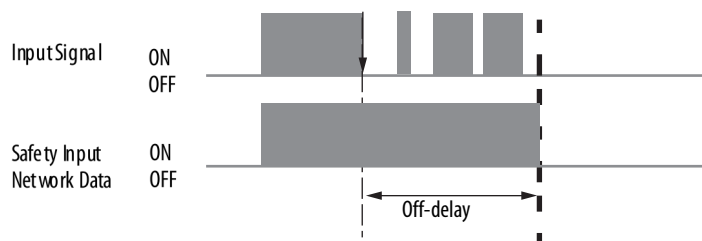

44.095

Safety Output Module Features

This section describes features that are available only on the FLEX 5000 I/O safety output modules.

The 5094-OB16S and 5094-OB16SXT modules are safety sourcing output module that use 16 digital safety outputs. You use the sourcing outputs in Sourcing Output mode.

Safety Application Suitability Levels

[Table 15](#) describes the safety application suitability levels for a 5094-OB16S or 5094-OB16SXT module.

Table 15 - Safety Application Suitability for 5094-OB16S and 5094-OB16SXT Module

Suitability Level	Conditions	Notes
Applications that are rated up to, and including, SIL 3 as defined in IEC 61508, IEC 61511, and IEC 62061, and PLc, cat. 2 as defined in ISO 13849-1	Use single-channel mode. <ul style="list-style-type: none"> Point mode is Safety Pulse Test or Safety. 	Consider the following: <ul style="list-style-type: none"> The channel mode type, that is, single or dual, affects Category. You can use the modules in SIL 3, PLc applications regardless of channel mode type.
Applications that are rated up to, and including, SIL CL3, PLc, Cat.4, as defined in IEC 61508, IEC 61551, IEC 62061, and ISO 13849-1	<ol style="list-style-type: none"> The module uses single-channel mode. <ul style="list-style-type: none"> Point mode is Safety Pulse Test or Safety. Use IEC60947 certified Safety Contactor. Use sheathed cable or cable trunk to separate channel wiring to mitigate short-circuit faults. The module uses dual-channel mode. <ul style="list-style-type: none"> Point mode is Safety. Use sheathed cable or cable trunk to separate channel wiring to mitigate short-circuit faults. The module uses dual-channel mode. <ul style="list-style-type: none"> Point mode is Safety Pulse Test. 	<ul style="list-style-type: none"> The requirement that Point mode be Safety Pulse Test assumes that only the safety I/O module provide diagnostics to a specific Suitability Level. The larger safety system within which the safety I/O module resides can provide the diagnostics necessary to achieve the stated Suitability Level without the requirement that Point mode be Safety Pulse Test. To achieve the specific Safety Integrity Level, see Appendix C, Application/Wiring Examples for Safety I/O Modules on page 159.

- Solid-state outputs
- Safety outputs can be pulse-tested to detect field wiring short circuits to 24V DC
- Supports field-power loss detection and configurable channel-level output state in Program mode and Communications Fault mode

Output Module in CIP Safety Systems

The following apply to the safety outputs:

- You can connect safety devices, such as safety relays, safety contactors.
- An external wiring short-circuit check between channels or supply is possible when the safety output is configured as Safety Pulse Test mode. When the safety output is configured as Safety mode, external wiring short-circuit check to supply is possible; check between channels is not supported. The detection of external wiring fault is ≤ 300 msec.
- Diagnostics. See [Status and Fault Information in Module Properties Categories](#).
- Safety output points are configured as the following:
 - Not Used
 - Safety
 - Safety Pulse Test
- Safety output point shall connect to a load that draws a minimum current of 10 mA while in the “ON” state.

Safety and Safety Pulse Test Mode

The Safety Output can be configured to two types of point modes:

- Safety Mode
- Safety Pulse Test Mode

When the safety output is configured to Safety Mode, the safety output channel continuously test the ability of the safety output switching elements ability to turn off while maintaining the safety output at its nominal voltage with less than 1 Volt change. This small voltage variation during the pulse test is insignificant for most of the connected device.

If an error is detected, the safety output data and individual safety output status turn off.

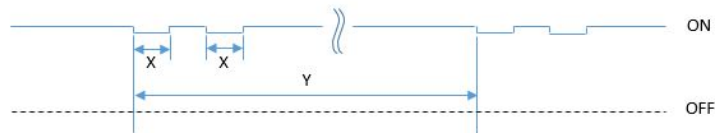

On the 5094-OB16S and 5094-OB16SXT modules, the pulse width (X) is less than 500 μ s, and the pulse period (Y) is less than 200 ms.

When the safety output is configured to Safety Pulse Test Mode, the safety output channel continuously test the ability of the safety output to remove power from the output terminals of the module. The safety output turn off momentarily during the pulse test duration.

If an error is detected, the safety output data and individual safety output status turn off.

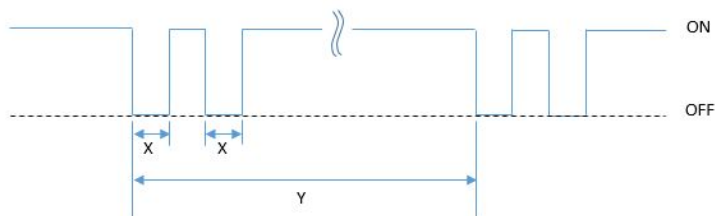

On the 5094-OB16S and 5094-OB16SXT modules, the pulse width (X) is less than 500 μ s, and the pulse period (Y) is less than 200 ms.

TIP To help prevent the test pulse from causing the connected device to malfunction, pay careful attention to the input response time of the output device.

Refer to [5094-OB16S and 5094-OB16SXT Module Wiring Diagrams](#) on [page 165](#) for more details about applying Safety Mode and Safety Pulse Test Mode in your application.

Single-channel Mode

When the output channel is in the On state and without any faults, the safety outputs turned on. The status is normal. If a fault is detected on the output channel, the safety output data and individual safety output status turn off.

For information about how using single-channel mode with a 5094-OB16S or 5094-OB16SXT module affects the safety application suitability level, see [Table 15 on page 77](#).

Figure 13 - 5094-OB16S/5094-OB16SXT Single-channel Mode (Not to Scale)

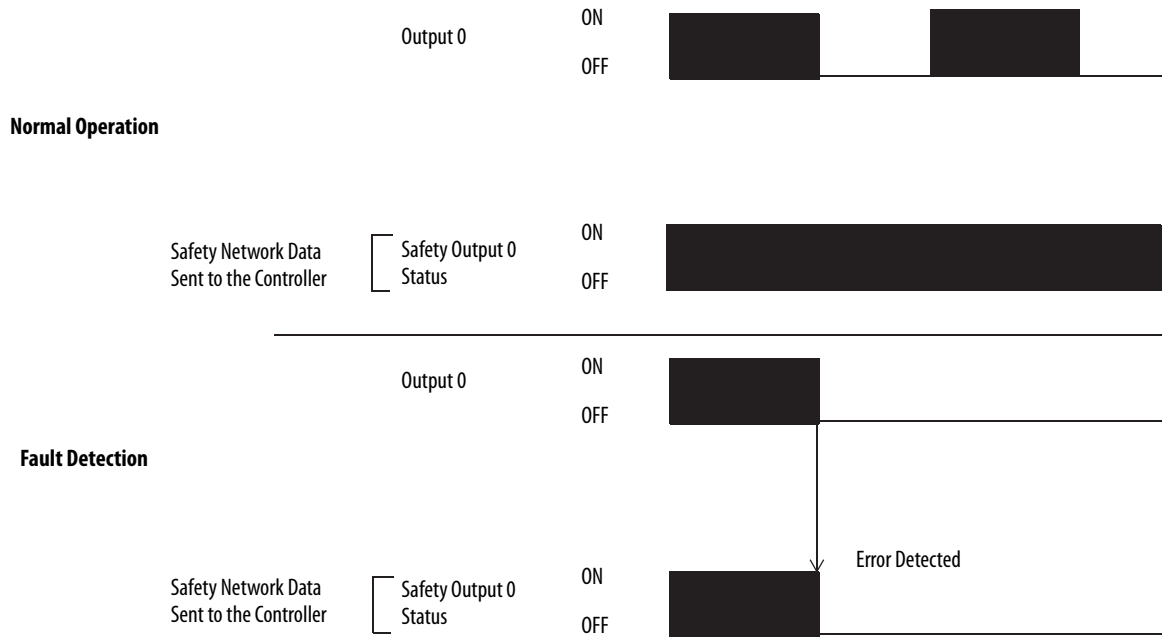

Dual-channel Mode

When dual-channel mode is used, output channels function as connection pairs. Connection pairs are as follows:

- Channels 0 and 1
- Channels 2 and 3
- Channels 4 and 5
- Channels 6 and 7
- Channels 8 and 9
- Channels 10 and 11
- Channels 12 and 13
- Channels 14 and 15

When both output channels in a connection pair are in the On state and without any faults, the safety outputs are turned on.

For information about how using dual-channel mode with a 5094-OB16S or 5094-OB16SXT module affects the safety application suitability level, see [Table 15 on page 77](#).

Figure 14 - 5094-OB16S Dual-channel Mode (Not to Scale)

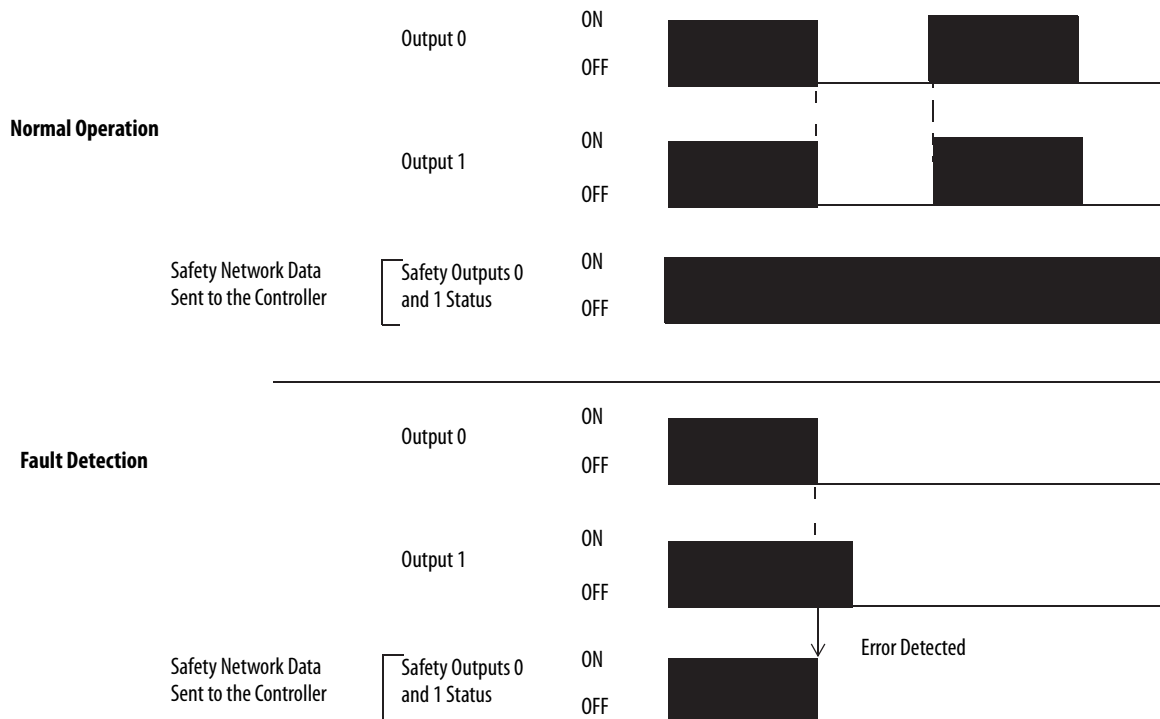

Surge Capability of Safety Output

The safety output supports temporary surge of current when transitioning from OFF to ON.

Figure 15 - Surge Capability of 5094-OB16S and 5094-OB16SXT

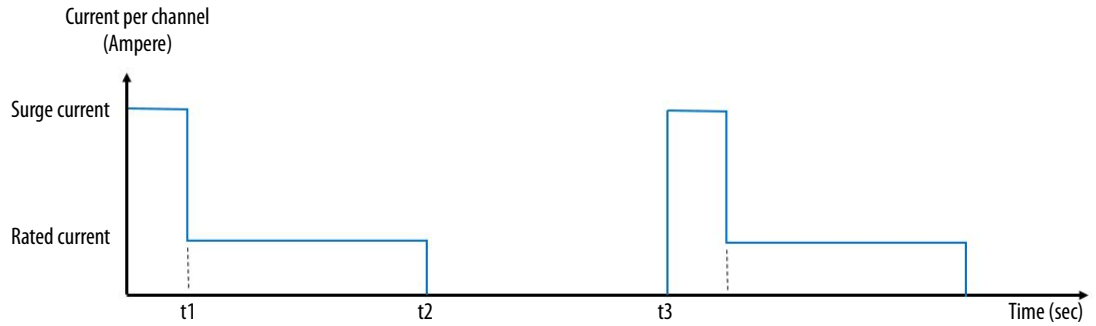

t1 = Surge time, maximum 150 msec
t2 = ON time
t3 - t2 = OFF time, 2 seconds

Surge Current per channel = 1.8 Amperes

IMPORTANT: The module current rating **cannot** exceed 10 Amperes at any time.

Safety Output Fault Reset

The I/O channel supports a module-level user-configurable 'Latch Fault until reset via output tag' mode and recovers from only these field faults:

- Field Power Off Detection
- Safety Output ShortCircuitGround
- Safety Output Overload

'Latch Fault until reset via output tag' mode is Enabled.

When Latch Fault... mode is Enabled, the I/O channel holds safety output fault indications until it checks that the field fault is removed. If the field fault is removed, the channel clears the fault status only upon detecting that the ResetFault in its consume assembly channel sees a rising edge.

'Latch Fault until reset via output tag' mode is Disabled.

When Latch Fault... mode is Disabled (default), the I/O channel holds safety output fault indications for 1 second until it checks if the field fault is removed. If the field fault is removed, the channel clears the fault status only upon detecting the consume data bit is low. The fault status will also be cleared by a module reset or power cycle, or when 'Output State During Program Mode and Communications Fault Mode' is configured to Off and any of these conditions:

- Controller in Program mode
- Controller or Safety task fault
- Communications fault
- Module inhibit

After the channel clears the fault, the I/O indicator (red) turns off. The output data can now be controlled.

IMPORTANT If the module outputs experience persistent high faults, consider cycling power to the module to clear the error.

Safety Relay Output Module Features

This section describes features that are available only on the FLEX 5000 relay 4-point safety output modules.

The 5094-OW4IS and 5094-OW4ISXT relay modules are safety output modules that use 4-point safety outputs.

Safety Application Suitability Levels

[Table 16](#) describes the safety application suitability levels for a 5094-OW4IS or 5094-OW4ISXT module.

Table 16 - Safety Application Suitability for 5094-OW4IS and 5094-OW4ISXT Module

Suitability Level	Conditions	Notes
Applications that are rated up to, and including, SIL CL2, PLd, Cat.3, as defined in IEC 61508, IEC 61551, IEC 62061, and ISO 13849-1	The modules uses single-channel mode <ul style="list-style-type: none"> – Signal state change at least once a year 	Consider the following: <ul style="list-style-type: none"> • To achieve SIL CL3 single-channel, the actuator that is used must be SIL CL3 single-channel as well.
Applications that are rated up to, and including, SIL CL3, PLe, Cat.4, as defined in IEC 61508, IEC 61551, IEC 62061, and ISO 13849-1	<ol style="list-style-type: none"> 1. The modules use single-channel mode: <ul style="list-style-type: none"> – Signal state change at least once a month 2. The modules use dual-channel mode: <ul style="list-style-type: none"> – Ladder logical alternative toggle each channel at least once a month 	<ul style="list-style-type: none"> • Use sheathed cable or cable trunk to separate channel wiring to mitigate short-circuit fault. • Fuse with proper rating should be connected to prevent relay contacts from overload and short circuit. • To achieve the specific Safety Integrity Level, see Appendix C, Application/Wiring Examples for Safety I/O Modules on page 159.

Safety Relay Output Module in CIP Safety Systems

The following apply to the safety relay outputs:

- You can connect safety devices, such as safety relays, safety contactors.
- Diagnostics. See [Status and Fault Information in Module Properties Categories](#).
- Safety relay output points are configured as the following:
 - Not Used
 - Safety

The safety relay module is rated up to 2A/channel when all 4 channels are used in 5...30V DC mode or 125/240V AC, 50/60 Hz mode. This module can also be used in 5...30V DC applications requiring up to 4A/channel with the restriction of using only channels 0 and 1; channels 2 and 3 are unused.

Snubber circuit is required when the relay output is used to drive inductive load. See the module wiring diagram requirements on [page 167](#).

Safety Relay Output Fault Reset

The I/O channel supports a module-level user-configurable 'Latch Fault until reset via output tag' mode and recovers from only this fault:

- Field Power Off Detection

'Latch Fault until reset via output tag' mode is Enabled.

When Latch Fault... mode is Enabled, the I/O channel holds safety output fault indications until it checks that the fault is removed. If the fault is removed, the channel clears the fault status only upon detecting that the ResetFault in its consume assembly channel sees a rising edge.

'Latch Fault until reset via output tag' mode is Disabled.

When Latch Fault... mode is Disabled (default), the I/O channel holds safety output fault indications for 1 second until it checks if the fault is removed. If the fault is removed, the channel clears the fault status only upon detecting the consume data bit is low. If not, the channel continues to check if the fault is removed.

After the channel clears the fault, the I/O indicator (red) turns off. The output data can now be controlled.

IMPORTANT If the module outputs experience persistent high faults, consider cycling power to the module to clear the error.

Fault and Status Reporting

The FLEX 5000 I/O safety modules produce fault and status data with channel data to the owner and listening controllers. The data is returned via module tags that you can monitor in your Logix Designer application.

For more information on how to use module tags to monitor fault and status reporting, see the following:

- 5094-IB16S and 5094-IB16SXT modules - [Table 34 on page 149](#)
- 5094-OB16S and 5094-OB16SXT modules - [Table 36 on page 150](#)
- 5094-OW4IS and 5094-OW4ISXT modules - [Table 42 on page 156](#)
- [Appendix A, Troubleshoot Your Module on page 123.](#)

Notes:

Configure the Standard Module

Standard Modules

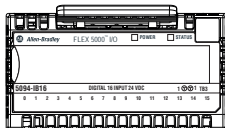

Topic	Page
Before You Begin	88
Create a New Module	88
Edit the Module Configuration Common Categories	93
Edit 5094-IB16 Module Configuration Categories	97
Edit 5094-OB16 Module Configuration Categories	103
Edit 5094-OW8I Module Configuration Categories	104
View the Module Tags	105

This chapter describes how to configure your FLEX 5000™ digital I/O modules in a Logix Designer application project. You can use the default module configuration or edit the module configuration.

IMPORTANT Consider the following:

- You must use the Studio 5000 Logix Designer® application, version 31 or later, to configure the FLEX 5000 I/O modules. Version 31 or later is slightly different from previous programming software versions. For example, in some cases, instead of tabs across the top of the Module Properties dialog box, the application uses categories on the left side of the dialog box.
- This chapter does not explain the user-configurable module features that you can edit on different screens in your Logix Designer application project.

For detailed information about module features, see the following:

- [Chapter 2, Common Digital I/O Module Features on page 45](#)
- [Chapter 3, Input Module Features on page 51](#)
- [Chapter 4, Output Module Features on page 55](#)

Before You Begin

You must complete the following tasks before you can configure the module:

1. Create a Logix Designer application project.
2. Add a FLEX 5000 EtherNet/IP adapter to the project.

For more information on how to add a FLEX 5000 EtherNet/IP adapter to a Logix Designer application project, see the EtherNet/IP Communication Modules in 5000 Series Systems User Manual, publication [ENET-UM004](#).

Create a New Module

After you create a Logix Designer application project and add a FLEX 5000 EtherNet/IP adapter to the project, you can use the following methods to add modules to the project.

- [Discover Modules](#)
- [New Module](#)

Discover Modules

To use the Discover Modules method with FLEX 5000 I/O modules, complete these steps.

1. Go online with your Logix Designer application.

The project must include a FLEX 5000 EtherNet/IP adapter.

2. Right-click the FLEX 5000 EtherNet/IP adapter and choose Discover Modules.

The Logix Designer application automatically detects available modules that are connected to the backplane.

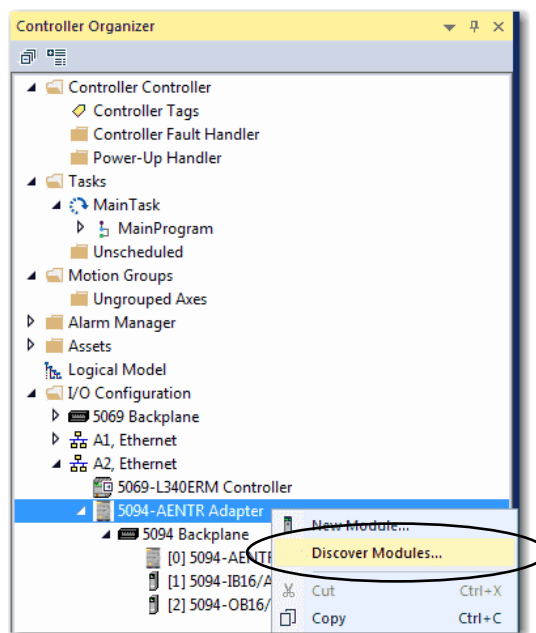

3. At the Select Module Type window, click Create to add the discovered module to your project.

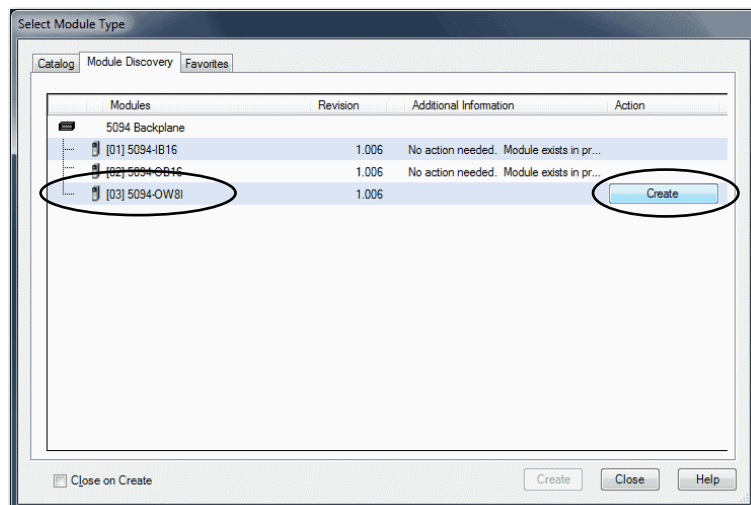

- At the New Module window, configure the module properties and click OK.

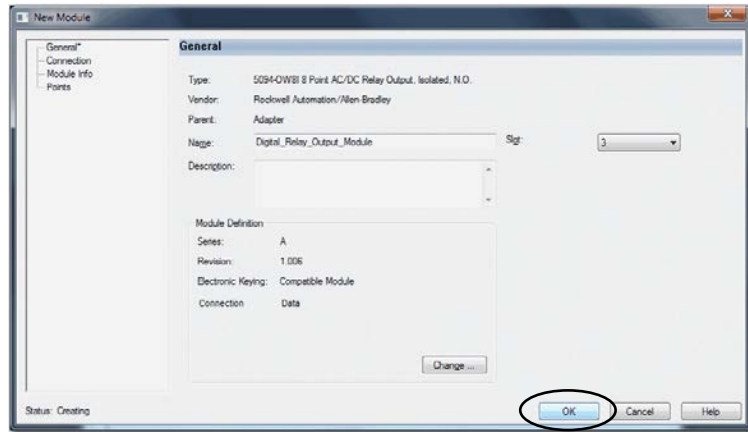

- At the warning dialog box, make sure that Inhibit module connection is selected and click Yes.

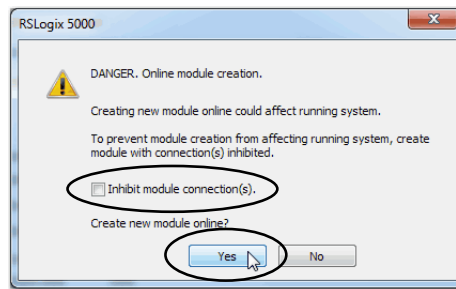

- Close the Select Module Type dialog box.

To add additional I/O modules with this method, complete one of the following:

- If you cleared the Close on Create check box when you created the first I/O module, repeat steps 3...6.
- If you did not clear the Close on Create checkbox when you created the first I/O module, repeat steps 2...6.

New Module

To use the New Module method with FLEX 5000 I/O modules, complete these steps.

TIP This example shows how to add an I/O module when the Logix Designer application project is offline.

You can add new modules when the project is online, if desired. In this case, the steps are similar to the steps described in [Discover Modules on page 89](#). One exception is that, in step 1, you choose New Module instead of Discover Modules.

1. Right-click the FLEX 5000 EtherNet/IP adapter and choose New Module.

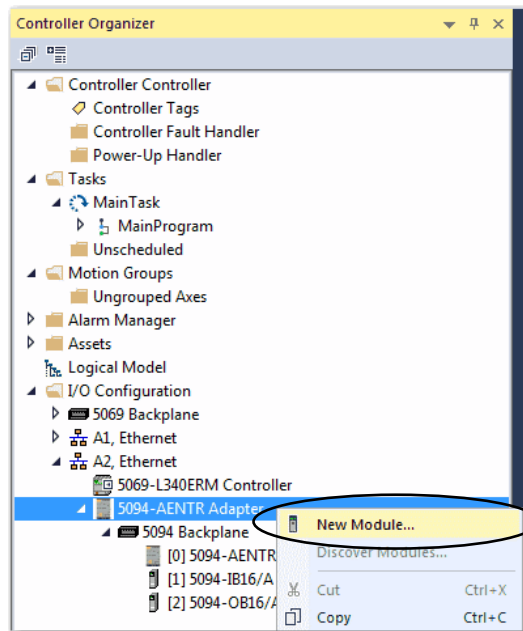

2. Select the module and click Create.

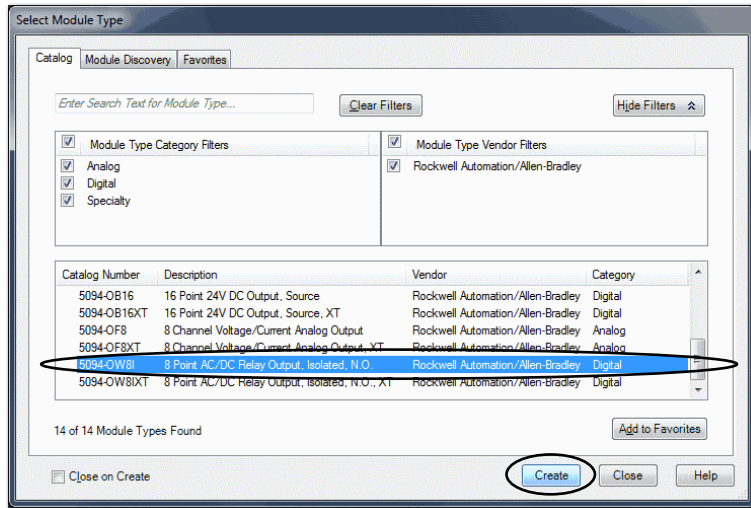

The New Module dialog box appears with a list of categories on the left side. The number and type of categories varies by module type.

3. You can click OK to use the default configuration as shown or edit the module configuration. The rest of this chapter describes how to edit module configuration categories.

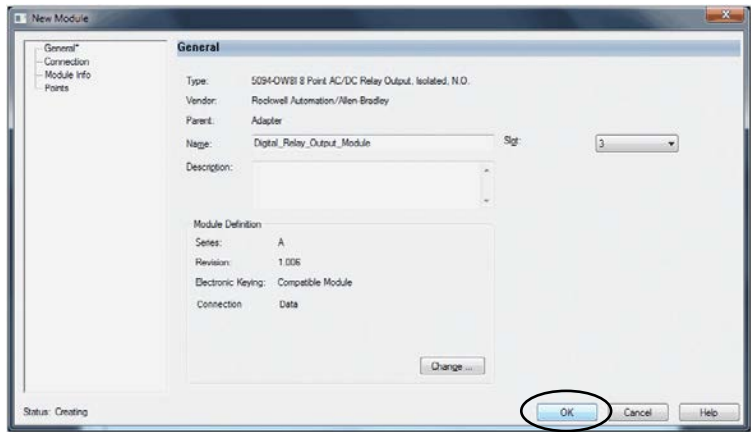

To add additional remote I/O modules with this method, complete one of the following:

- If you cleared the Close on Create checkbox when you created the first I/O module, repeat steps 2...3.
- If you did not clear the Close on Create checkbox when you created the first I/O module, repeat steps 1...3.

Edit the Module Configuration Common Categories

You click the category names in the New Module dialog box to view and change the configuration parameters.

IMPORTANT This chapter shows how to edit configuration when you add the module to the Logix Designer application project.

If you access the module configuration after it is added to the project, the dialog box is named Module Properties. The same categories are displayed as the categories displayed on the New Module dialog box.

Some new module configuration categories apply to all FLEX 5000 digital I/O modules. Some categories are specific to the module type.

For example purposes, the figures in this section are from a 5094-IB16 module.

The following categories apply to all FLEX 5000 digital I/O modules and are described in this section.

- [General Category](#)
- [Connection Category](#)
- [Module Info Category](#)

General Category

The General category appears first when you create a module. The parameters in this category are the same for all FLEX 5000 digital I/O modules.

You use this category to complete the following tasks:

- Name the module.
- Assign a slot number. (required)
- Describe the module.
- Access the Module Definition.

Module Definition

Module Definition parameters are available on the General tab of the Module Properties dialog box in the Logix Designer application project.

Table 17 describes the parameters on the Module Definition dialog box.

IMPORTANT The graphic is an example of a Module Definition dialog box. The same set of fields and options are not available on all FLEX 5000 I/O modules.

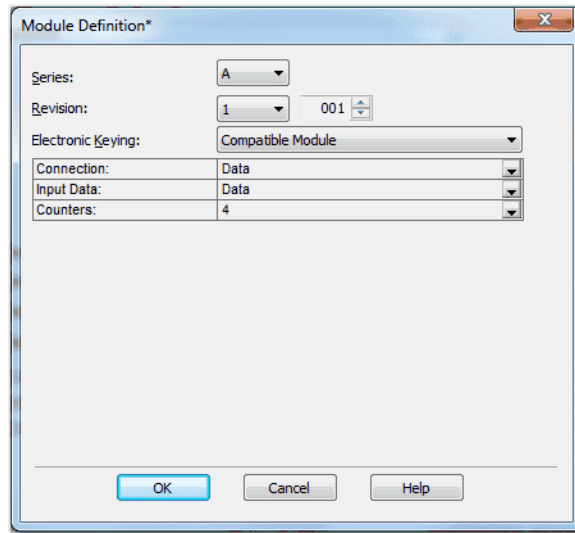

Table 17 - Module Definition Parameters

Parameter	Definition	Available Choices ⁽¹⁾
Series	Module hardware series	Module-specific
Revision	Module firmware revision, including major and minor revision levels	Module-specific
Electronic Keying	Software method by which you reduce the possibility of using the wrong device in a control system. For more information, see the following: <ul style="list-style-type: none"> • View the Module Tags on page 105 • Electronic Keying in Logix5000 Control Systems Application Technique, publication LOGIX-AT001 	Exact Match Compatible Module Disable Keying
Connection	Determines the following for the module type you configure: <ul style="list-style-type: none"> • Available configuration parameters • Data type transferred between the module and the controller • Which tags are generated when configuration is complete 	Data Data with Events Listen Only Data ⁽²⁾ Listen Only Data with Events ⁽²⁾
Input Data - Input modules only	All available configurations, input data. This connection type creates all controller tags specific to the module type being used.	Data Timestamped Data Packed Data
Counters - Input modules only	Determines the number of counters that are used for the module type.	None 4 8
Output Data - Output modules only	All available configurations, output data. This connection type creates all controller tags specific to the module type being used.	Data Scheduled Data Packed Data

(1) The choices that are available vary by module type and catalog number.

(2) Controller and module establish communication without the controller sending any configuration or output data to the module. A full input data connection is established but depends on the connection between the owner-controller and the module.

Connection Category

The Connection category lets you complete the following tasks:

- Set the RPI rate. For more information on the RPI, see [Data Types Available with FLEX 5000 Standard I/O Modules on page 27](#).
- Set the connection type to use on the EtherNet/IP network.

For more information on unicast and multicast connections, see the EtherNet/IP Communication Modules in 5000 Series Systems User Manual, publication [ENET-UM004](#).

- Inhibit the module. For more information on how to inhibit the module, see [Module Inhibiting on page 49](#).
- Configure whether a connection failure while the controller is in Run module causes a major or minor fault.

TIP The Module Fault area of the Connection category is useful during module troubleshooting. For more information on the Module Fault area, see [page 133](#).

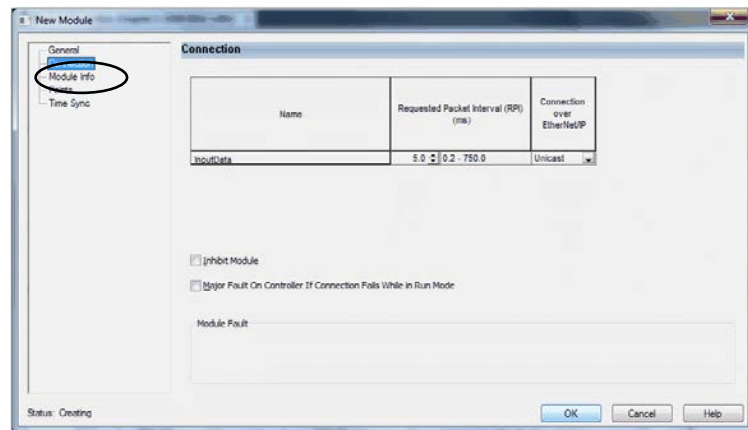

Module Info Category

The Module Info category displays module and status information about the module when the project is online. You can use this category to complete the following:

- Determine the identity of the module.
- Access module diagnostics.
- Refresh the data on the screen.
- Reset the module.

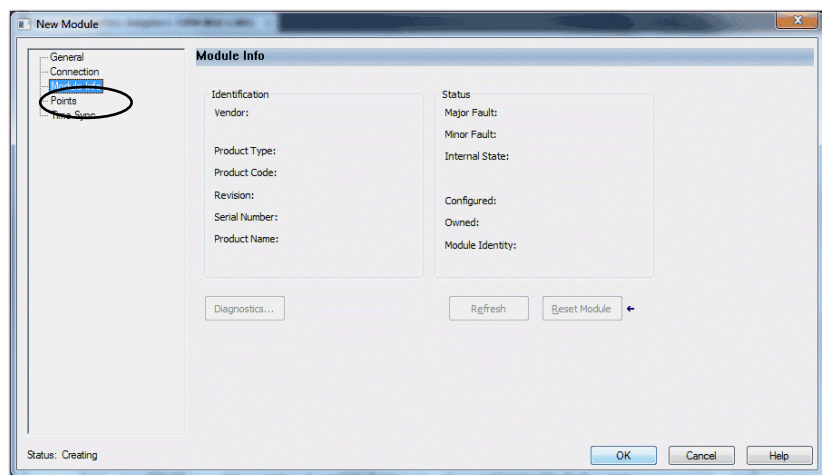

Edit 5094-IB16 Module Configuration Categories

In addition to the General, Connection, and Module Info categories, the following categories are available when you configure a 5094-IB16 module:

- [Counters Category](#)
- [Points Category](#)
- [Events Category](#)
- [Time Sync Category](#)

IMPORTANT If you use the Listen Only Data or Listen Only Data with Events connection type, the Points Category, Counters Category, and Events Category do not appear.

Counters Category

The Counters category is available only if you choose a value for Counters in the Module Definition dialog box.

The Counters category shows the configuration options available for each counter. Based on your Input Filter Time selections, the Input Filter Time Off→On and On→Off times change. You can also configure the counter Preset value and enable Rollover at Preset.

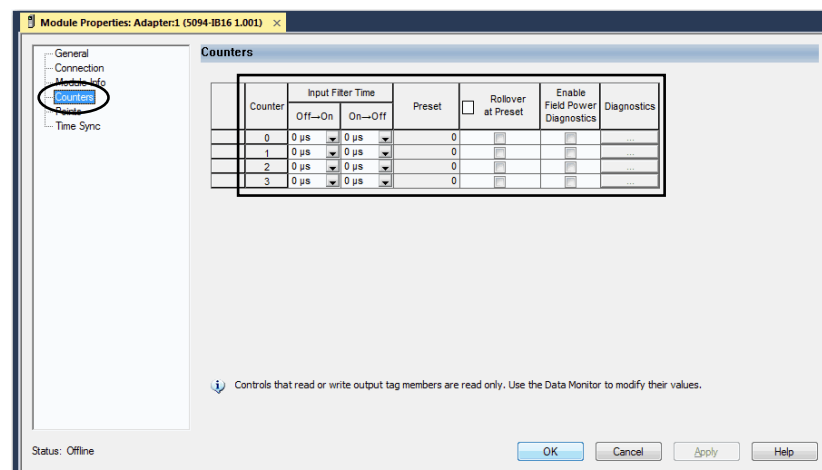

IMPORTANT The total number of Counters subtracts from the available number of Points. For example, if you configure a 5094-IB16 module to use four counters, the first four terminals are not available to use as points.

The number of points available on the module in this case is 12. That is, points 4... 15.

Points Category

The Points category shows the available input filter time values for the module points.

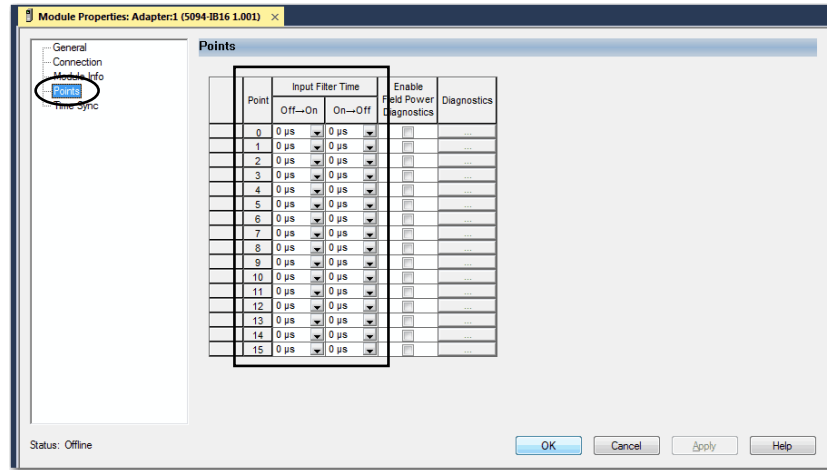

If you choose Timestamped Data for Input Data in the Module Definition dialog box, the Points category expands.

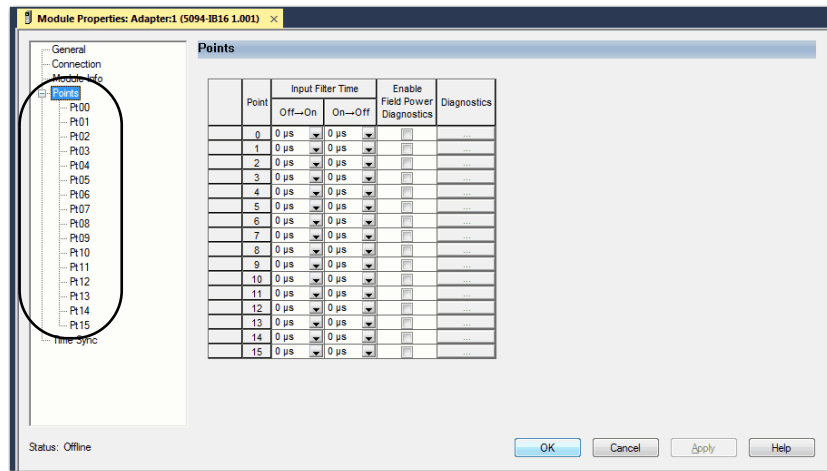

PTxx Category

The PT xx category shows the configuration options available when you use Timestamping on a point.

IMPORTANT You must choose the Input Data option Timestamp Data on the Module Definition dialog box to see this category in the Module Properties dialog box.

Click each P txx to configure it as necessary for your application.

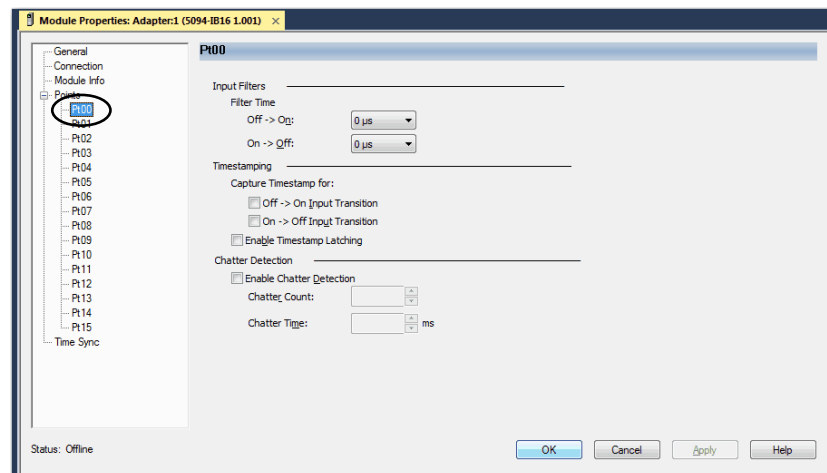

Events Category

The Events category is available only if you choose Data with Events for Connection in the Module Definition dialog box. Click the + sign next to the Events category to expand it.

IMPORTANT You cannot configure events on the Module Properties dialog box. The parameters that are displayed are read-only.

You must use the Event Output tags to configure an event. For more information, see [Configure an Event in the Event Output Tags on page 101](#).

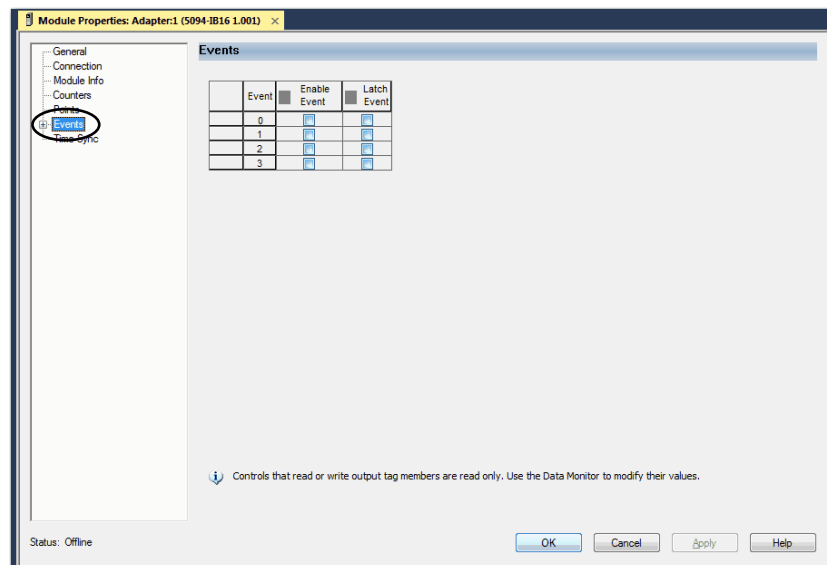

The Events subcategories show the configuration parameters for events.

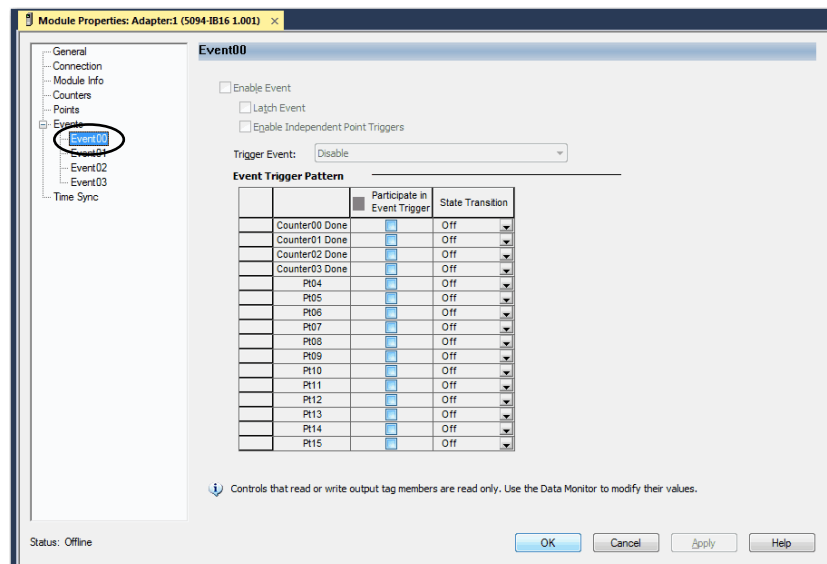

Configure an Event in the Event Output Tags

To configure an event, you must change the Event Output tags for the affected module via the Tag Monitor in the Logix Designer application. When you change the tags, the change is reflected on the Module Properties dialog box.

The following graphics show how tag values are reflected on the Module Properties. The following conditions are shown:

- Event is enabled
- Point 4 is configured to trigger the event
- Event is latched
- Trigger Event is on input transition to match pattern

These changes in the Event Output tags configure the event. After the tags are changed, the related parameters on the Module Properties are updated automatically.

Name	Value	Force Mask
Adapter:1:EO.Event00	1	[...]
Adapter:1:EO.Event00.En	1	
Adapter:1:EO.Event00.EventRisingEn	1	
Adapter:1:EO.Event00.EventFallingEn	0	
Adapter:1:EO.Event00.LatchEn	1	
Adapter:1:EO.Event00.ResetEvent	0	
Adapter:1:EO.Event00.IndependentConditionTriggerEn	0	
Adapter:1:EO.Event00.EventNumberAck	0	
Adapter:1:EO.Event00.Counter00Select	0	
Adapter:1:EO.Event00.Counter01Select	0	
Adapter:1:EO.Event00.Counter02Select	0	
Adapter:1:EO.Event00.Counter03Select	0	
Adapter:1:EO.Event00.Pt04DataSelect	1	
Adapter:1:EO.Event00.Pt05DataSelect	0	
Adapter:1:EO.Event00.Pt06DataSelect	0	

	#	Participate in Event Trigger	State Transition
Counter00 Done		<input type="checkbox"/>	Off
Counter01 Done		<input type="checkbox"/>	Off
Counter02 Done		<input type="checkbox"/>	Off
Counter03 Done		<input type="checkbox"/>	Off
Pt04		<input checked="" type="checkbox"/>	Off
Pt05		<input type="checkbox"/>	Off
Pt06		<input type="checkbox"/>	Off
Pt07		<input type="checkbox"/>	Off
Pt08		<input type="checkbox"/>	Off
Pt09		<input type="checkbox"/>	Off
Pt10		<input type="checkbox"/>	Off

For more information on module tags, see the following:

- [View the Module Tags on page 105](#)
- [Appendix B, Module Tag Definitions on page 139](#)

Time Sync Category

The Time Sync category displays and status information about the module when the project is online. The Time Sync category displays the following information:

- CIP Sync™ Time Synchronization
- UTC System Time
- Grandmaster Clock information
- Local Clock information

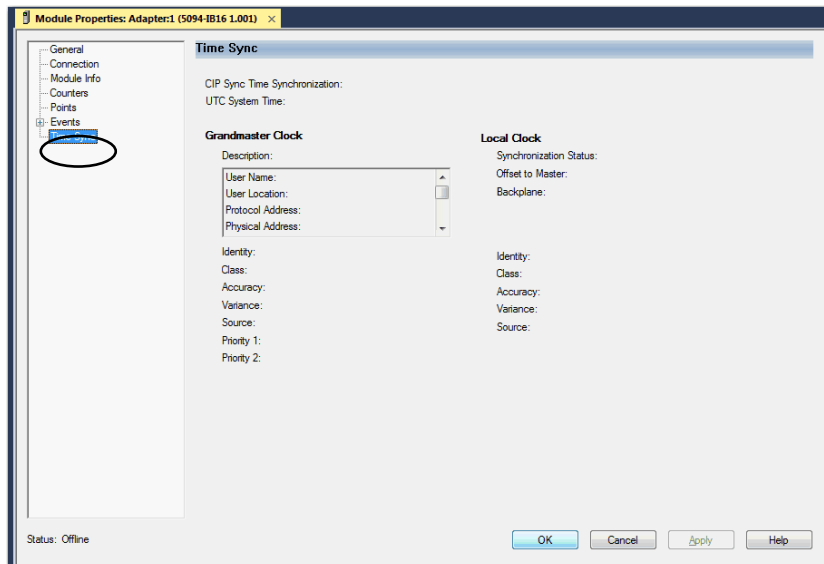

Edit 5094-OB16 Module Configuration Categories

In addition to the General, Connection, and Module Info categories, the Points category is available when you configure a 5094-OB16 module.

IMPORTANT If you use the Listen Only Data connection type, the Points Category does not appear.

Points Category

The Points category shows the configuration options available for each point. You can configure the following parameters from the Points category:

- Output State During Program Mode
- Output State During Fault Mode
- Fault Mode Output State Duration
- Fault Mode Output State Final State
- Output State When Communications Fail in Program Mode
- Enable No Load Diagnostics

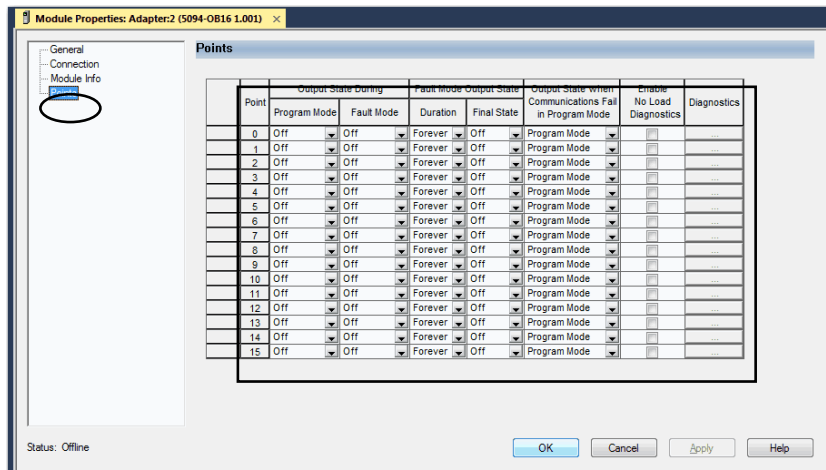

Edit 5094-OW8I Module Configuration Categories

In addition to the General, Connection, and Module Info categories, the Points category is available when you configure a 5094-OW8I module.

IMPORTANT If you use the Listen Only Data connection type, the Points Category does not appear.

Points Category

The Points category shows the configuration options available for each point. You can configure the following parameters from the Points category:

- Output State During Program Mode
- Output State During Fault Mode
- Fault Mode Output State Duration
- Fault Mode Output State Final State
- Output State When Communications Fail in Program Mode

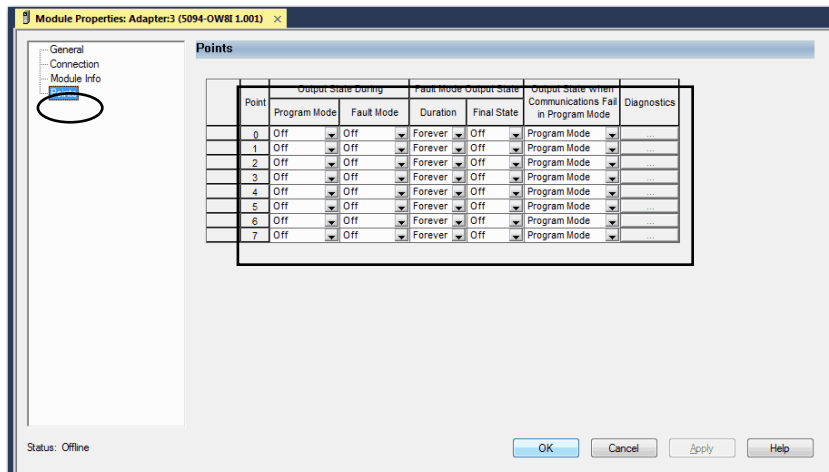

View the Module Tags

When you create a module, the Logix Designer application creates a set of tags that you can view in the Tag Editor. Each configured feature on your module has a distinct tag that is available for use in the controller program logic.

Complete the following steps to access the module tags.

1. In the Controller Organizer, right-click Controller Tags and choose Monitor Tags.

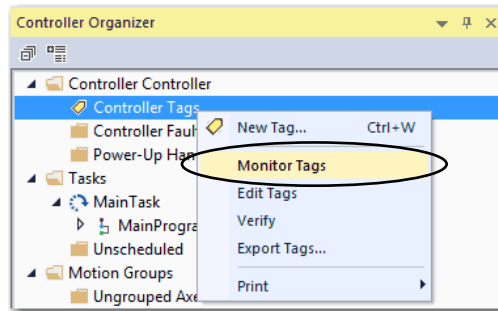

The Controller Tags dialog box appears with data.

2. To view the tags, click the  symbols as shown.

The screenshot shows the 'Controller Tags - Controller(controller)' dialog box. The table below lists the tags, with a red circle highlighting the play button icons in the 'Name' column.

Name	Value	Force Mask	Style	Data Type
Adapter1:C	{...}	{...}	{...}	AB:5000_DI6_Diag_Timestamp:C:0
▶ Adapter1:C.P00	{...}	{...}	{...}	AB:5000_DI_Diag_Timestamp_Channel:C:0
▶ Adapter1:C.P01	{...}	{...}	{...}	AB:5000_DI_Diag_Timestamp_Channel:C:0
▶ Adapter1:C.P01.InputOffOnFilter	5		Decimal	SINT
▶ Adapter1:C.P01.InputOffOnFilter.0	1		Decimal	BOOL
▶ Adapter1:C.P01.InputOffOnFilter.1	0		Decimal	BOOL
▶ Adapter1:C.P01.InputOffOnFilter.2	1		Decimal	BOOL
▶ Adapter1:C.P01.InputOffOnFilter.3	0		Decimal	BOOL
▶ Adapter1:C.P01.InputOffOnFilter.4	0		Decimal	BOOL
▶ Adapter1:C.P01.InputOffOnFilter.5	0		Decimal	BOOL
▶ Adapter1:C.P01.InputOffOnFilter.6	0		Decimal	BOOL
▶ Adapter1:C.P01.InputOffOnFilter.7	0		Decimal	BOOL
▶ Adapter1:C.P01.InputOnOffFilter	5		Decimal	SINT
▶ Adapter1:C.P01.ChatterTime	1000		Decimal	INT
▶ Adapter1:C.P01.ChatterCount	0		Decimal	SINT
▶ Adapter1:C.P01.CaptureOnOffEn	0		Decimal	BOOL
▶ Adapter1:C.P01.CaptureOnOffEn	0		Decimal	BOOL
▶ Adapter1:C.P01.TimestampLatchEn	0		Decimal	BOOL
▶ Adapter1:C.P01.FieldPowerDiagEn	0		Decimal	BOOL
▶ Adapter1:C.P02	{...}	{...}	{...}	AB:5000_DI_Diag_Timestamp_Channel:C:0
▶ Adapter1:C.P03	{...}	{...}	{...}	AB:5000_DI_Diag_Timestamp_Channel:C:0
▶ Adapter1:C.P04	{...}	{...}	{...}	AB:5000_DI_Diag_Timestamp_Channel:C:0
▶ Adapter1:C.P05	{...}	{...}	{...}	AB:5000_DI_Diag_Timestamp_Channel:C:0
▶ Adapter1:C.P06	{...}	{...}	{...}	AB:5000_DI_Diag_Timestamp_Channel:C:0
▶ Adapter1:C.P07	{...}	{...}	{...}	AB:5000_DI_Diag_Timestamp_Channel:C:0
▶ Adapter1:C.P08	{...}	{...}	{...}	AB:5000_DI_Diag_Timestamp_Channel:C:0

For more information on module tags, see [Appendix B, Module Tag Definitions on page 139](#).

Notes:

Configure and Replace Safety Modules

Safety Modules



Topic	Page
Before You Begin	108
Create a New Module	108
Edit the Module Configuration Common Categories	110
Edit the 5094-IB16S or 5094-IB16SXT Module Configuration Categories	115
Edit the 5094-OB16S or 5094-OB16SXT Module Configuration Category	117
Edit the 5094-OW4IS or 5094-OW4ISXT Module Configuration Category	117
View the Module Tags	118
Replace a Module	118

This chapter describes how to configure your FLEX 5000™ safety I/O modules in a Logix Designer application project.

IMPORTANT You must use the Logix Designer application, version 32 or greater with the modules.

This chapter does not explain the user-configurable parameters, or corresponding module features, in your Logix Designer application project.

For detailed information about module features, see the following:

- [Chapter 2, Common Digital I/O Module Features on page 45](#)
- [Chapter 3, Input Module Features on page 51](#)
- [Chapter 4, Output Module Features on page 55](#)
- [Chapter 5, Safety I/O Module Features on page 69](#)

IMPORTANT By default, all safety input and output channels on FLEX 5000 safety I/O modules are disabled.

You must configure each point that is used in a safety application.

Before You Begin

You must complete the following tasks before you can configure the module:

1. Create a Logix Designer application project.
2. If you use the FLEX 5000 safety I/O modules as remote I/O modules, add a FLEX 5000 I/O EtherNet/IP adapter to the project.

For more information on how to add a FLEX 5000 I/O EtherNet/IP adapter to a Logix Designer application project, see the EtherNet/IP Communication Modules in 5000 Series Systems User Manual, publication [ENET-UM004](#).

Once the project is created and, if necessary, the adapter is added, you can create a new module in the Logix Designer application project.

Create a New Module

Unlike FLEX 5000 standard I/O modules, you cannot add FLEX 5000 safety I/O modules to a Logix Designer project while the project is online. The project must be offline to add FLEX 5000 safety I/O modules to it.

You can create a new FLEX 5000 safety I/O module. I/O modules are installed in a system that includes a FLEX 5000 I/O EtherNet/IP adapter that connects to an EtherNet/IP network.

New I/O Module

To create a new FLEX 5000 safety I/O module, complete these steps.

1. Add a FLEX 5000 I/O EtherNet/IP adapter to the project.

This example uses a 5094-AENTR or 5094-AEN2TR adapter.

2. Right-click the FLEX 5000 I/O EtherNet/IP adapter and choose New Module.

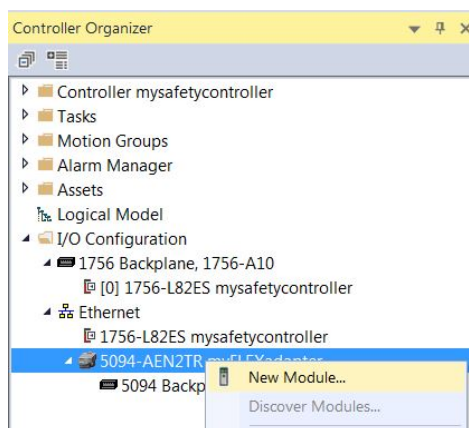

3. Select the module and click Create.

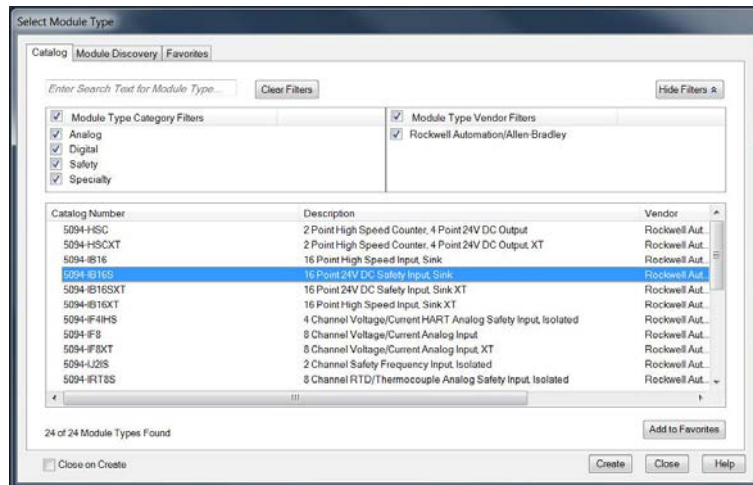

The New Module dialog box appears with a list of categories on the left side. The number and type of categories varies by module type.

4. You can click OK to use the default configuration as shown or edit the module configuration. The rest of this chapter describes how to edit module configuration categories.

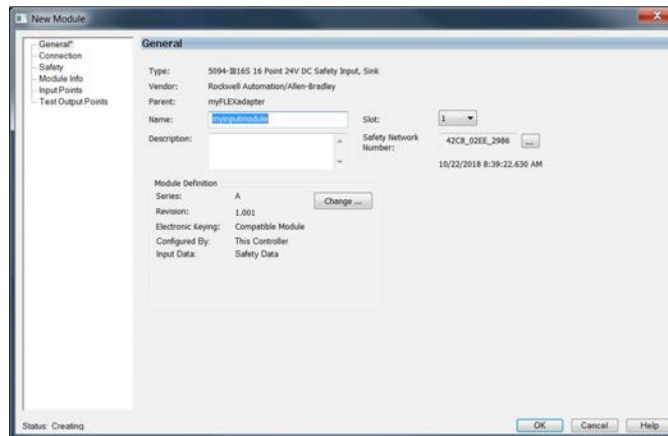

To add additional I/O modules with this method, complete one of the following:

- If you cleared the Close on Create checkbox when you created the first I/O module, repeat steps [3...4](#).
- If you did not clear the Close on Create checkbox when you created the first I/O module, repeat steps [2...4](#).

Edit the Module Configuration Common Categories

You click the category names in the New Module dialog box to view and change the configuration parameters. Before you edit the module configuration, consider the following:

- This chapter shows how to edit configuration when you add the module to the Logix Designer application project.

If you access the module configuration after it is added to the project, the dialog box is named Module Properties. The same categories are displayed as the categories displayed on the New Module dialog box.

- Some new module configuration categories apply to all FLEX 5000 digital safety I/O modules. Some categories are specific to the module type.

IMPORTANT By default, all safety input and output channels on FLEX 5000 safety I/O modules are disabled.

You must configure each point that is used in a Safety application.

The following categories apply to all FLEX 5000 digital safety I/O modules and are described in these sections:

- [General Category](#)
- [Connection Category](#)
- [Safety Category](#)
- [Module Info Category](#)

General Category

The General category appears first when you create a module. The parameters in this category are the same for all FLEX 5000 digital I/O modules.

You use this category to complete the following tasks:

- Name the module.
- Assign a node number.
- Describe the module.
- Access the Module Definition.

Safety Network Number

The Logix Designer application automatically assigns a Safety Network Number (SNN) to FLEX 5000 safety I/O modules as they are added to the project.

The SNN is a time-based number that uniquely identifies subnets across all networks in the safety system. All FLEX 5000 safety I/O modules in a same system use the same SNN and are automatically assigned the same SNN by default.

The Logix Designer application assigns an SNN to the first safety module that is added to a remote system. The application assigns the same SNN to additional safety modules that are added to this remote I/O system.

For more information on Safety Network Numbers, see the GuardLogix 5580 and Compact GuardLogix 5380 Controller Systems Safety Reference Manual, publication [1756-RM012](#).

Module Definition

Module Definition parameters are available on the General tab of the Module Properties dialog box in the Logix Designer application project.

5094-IB16S and 5094-IB16SXTModules

5094-OB16S and 5094-OB16SXTModules

[Table 18](#) describes the parameters that are available on the Module Definition dialog box.

Table 18 - Module Definition Parameters

Parameter	Definition	Available Choices
Series	Module hardware series	Module-specific
Revision	Module firmware revision, including major and minor revision levels	Module-specific
Electronic Keying	Software method by which you reduce the possibility of using the wrong device in a control system. For more information, see the following: <ul style="list-style-type: none"> • Electronic Keying on page 50 • Electronic Keying in Logix5000 Control Systems Application Technique, publication LOGIX-AT001 	<ul style="list-style-type: none"> • Exact Match • Compatible Module
Configured By	Determines the following for the module type you configure: <ul style="list-style-type: none"> • Which controller tags are generated when configuration is complete 	<ul style="list-style-type: none"> • This Controller • External Means⁽¹⁾
Input Data	Determines what type of input data is exchanged between the module and the controller. Creates all controller tags specific to the module type being used.	<ul style="list-style-type: none"> • Safety data • Safety packed data
Output Data - 5094-OB16S and 5094-OB16SXT modules only	Determines what type of output data is exchanged between the module and the controller. The available choices are dictated by the Configured By parameter choice.	<ul style="list-style-type: none"> • None - If Configured By is External Means. • Safety data and Safety packed data - If Configured By is This Controller.

(1) Controller and module establish communication without the controller sending any configuration or output data to the module. A full input data connection is established but depends on the connection between the owner-controller and the module.

Connection Category

The Connection category lets you inhibit the module.

Before you inhibit the module, make sure that you are aware of the impact it has on your application. For more information on inhibiting the module, see [page 49](#).

IMPORTANT Unlike FLEX 5000 standard I/O modules, you cannot set the RPI for FLEX 5000 safety I/O modules on the Connections category. For FLEX 5000 safety I/O modules, you set the RPI on the Safety category.



Connection Over the EtherNet/IP Network

Remote FLEX 5000 safety I/O modules support the Connection over EtherNet/IP parameter.

- With safety input data, you can choose Unicast or Multicast.
- With safety output data, you **must** choose Unicast.

For more information on unicast and multicast connections, see the EtherNet/IP Communication Modules in 5000 Series Systems User Manual, publication [ENET-UM004](#).

Safety Category

The Safety category lets you set the RPI rate.

To change the Connection Reaction Time Limit configuration, click Advanced.

IMPORTANT Remember, the Safety Task period determines the 5094-OB16S module RPI.

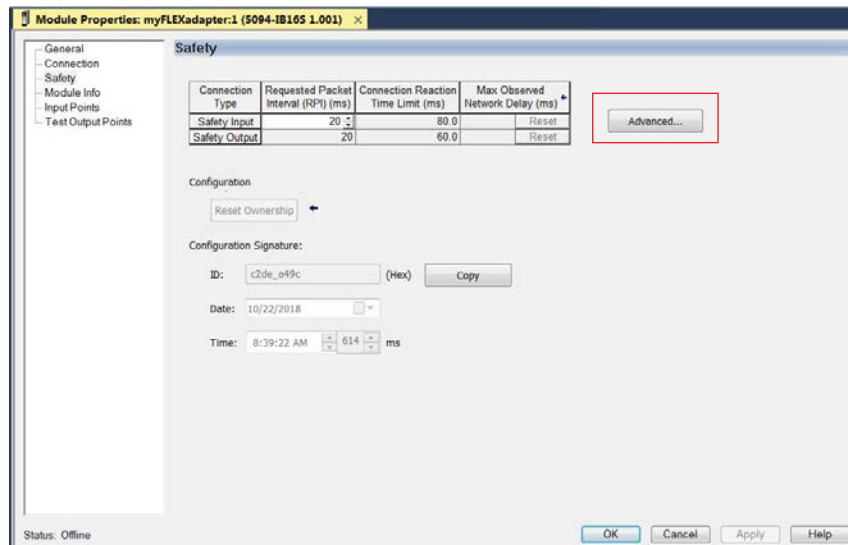

For more information on the RPI and the Connection Reaction Time Limit parameters, see [Requested Packet Interval on page 26](#).

Module Info Category

The Module Info category displays module and status information about the module when the project is online. You can use this category to complete the following:

- Determine the identity of the module.
- Access module diagnostics.
- Refresh the data on the screen.
- Reset the module.

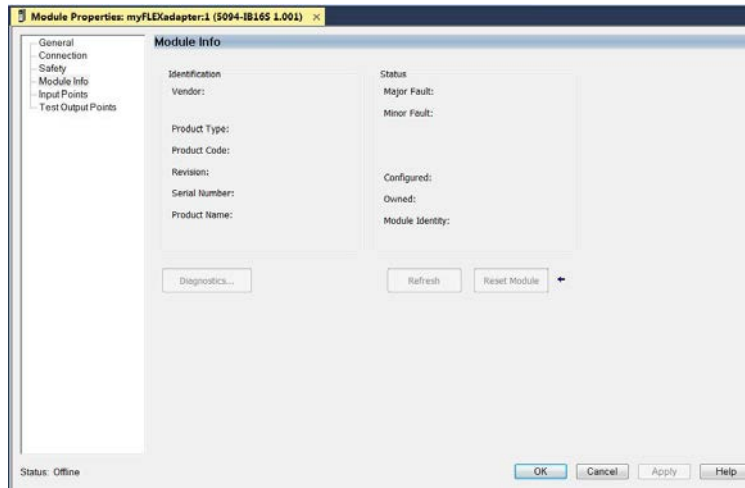

Edit the 5094-IB16S or 5094-IB16SXT Module Configuration Categories

These categories are available when you configure a 5094-IB16S or 5094-IB16SXT module:

- [Input Points Category](#)
- [Test Output Points Category](#)

Input Points Category

The Input Points category is only available if you choose This Controller for the Configured By parameter on the Module Definition dialog box.

You must configure each point to use it in a Safety application. The inputs are disabled by default.

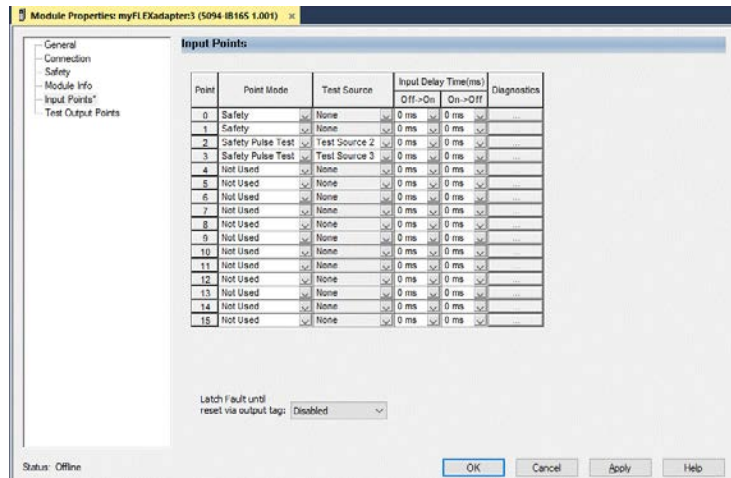

For more information on input delay times, see [page 75](#).

Test Output Points Category

The Test Output Points category is only available if you choose This Controller for the Configured By parameter on the Module Definition dialog box.

You must configure each point to use it in a safety application. The outputs are disabled by default.

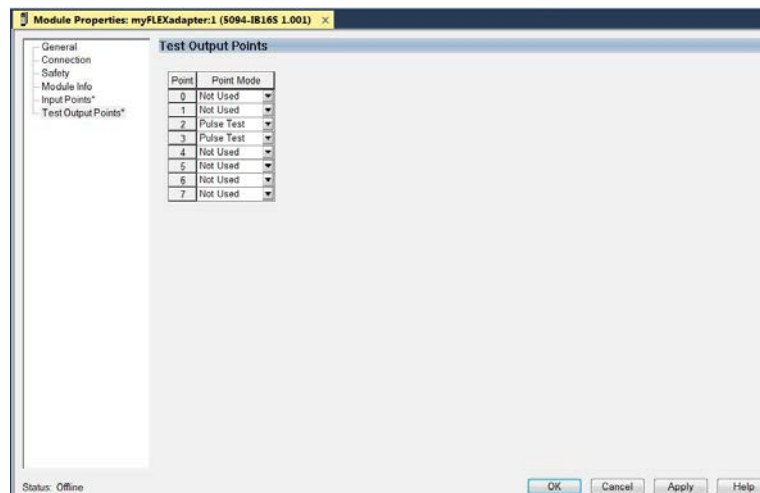

Edit the 5094-OB16S or 5094-OB16SXT Module Configuration Category

The 5094-OB16S or 5094-OB16SXT module uses the Output Configuration category.

The Points Configuration category is only available if you choose This Controller for the Configured By parameter on the Module Definition dialog box.

You must configure each point to use it in a safety application. The outputs are disabled by default.

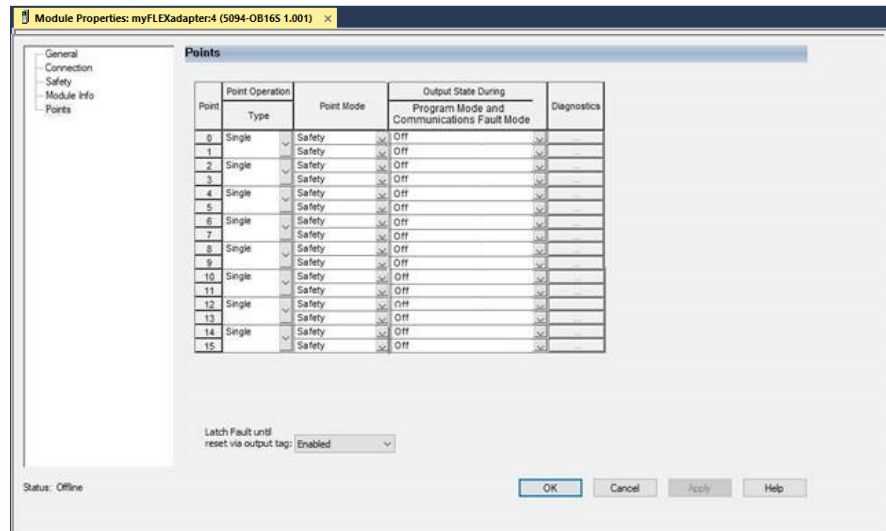

Edit the 5094-OW4IS or 5094-OW4ISXT Module Configuration Category

The 5094-OW4IS or 5094-OW4ISXT relay module uses the Output Configuration category.

The Points Configuration category is only available if you choose This Controller for the Configured By parameter on the Module Definition dialog box.

You must configure each point to use it in a safety application. The outputs are disabled by default.

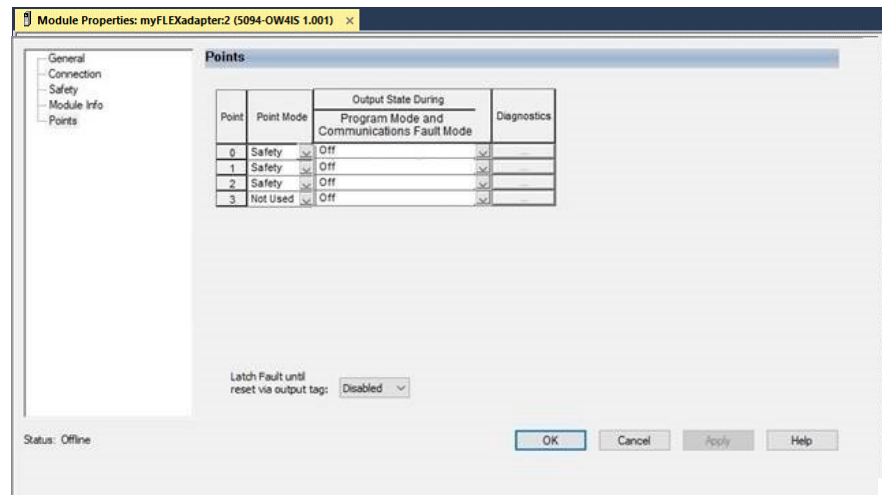

View the Module Tags

When you create a module, the Logix Designer application creates a set of tags that you can view in the Tag Editor. Each configured feature on your module has a distinct tag that is available for use in the controller program logic.

Complete the following steps to access the tags for a module.

1. In the Controller Organizer, right-click Controller Tags and choose Monitor Tags.

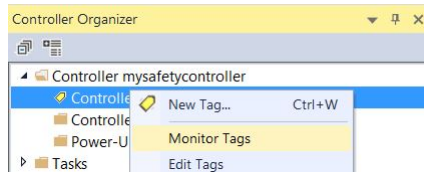

The Controller Tags dialog box appears with data.

2. To view the tags, click the triangle symbols.

The screenshot shows the 'Controller Tags - mysafetycontroller(controller)' dialog box. It displays a table of tags with columns for Name, Value, Force Mask, Style, Data Type, and Class. The 'myFLEXadapter:1:Pi00' folder is expanded, showing its sub-tags.

Name	Value	Force Mask	Style	Data Type	Class
myFLEXadapter:1:1	[-]	[-]	[-]	AB:5000_SDI1610	Safety
myFLEXadapter:1:1.RunMode	0		Decimal	BOOL	Safety
myFLEXadapter:1:1.ConnectionFaulted	1		Decimal	BOOL	Safety
myFLEXadapter:1:1.DiagnosticActive	0		Decimal	BOOL	Safety
myFLEXadapter:1:1.DiagnosticSequenceCount	0		Decimal	SINT	Safety
myFLEXadapter:1:1.Pi00	[-]	[-]	[-]	CHANNEL_SDI10	Safety
myFLEXadapter:1:1.Pi00.Data	0		Decimal	BOOL	Safety
myFLEXadapter:1:1.Pi00.Fault	1		Decimal	BOOL	Safety
myFLEXadapter:1:1.Pi00.Uncertain	0		Decimal	BOOL	Safety
myFLEXadapter:1:1.Pi00.ShortCircuit	0		Decimal	BOOL	Safety
myFLEXadapter:1:1.Pi00.Status	0		Decimal	BOOL	Safety

For more information on module tags, see [Appendix B, Module Tag Definitions on page 139](#)

Replace a Module

Replacing a safety module that sits on a CIP Safety™ network is more complicated than replacing standard devices because of the safety network number (SNN).

Safety devices require this more complex identifier to make sure that module numbers that are duplicated on separate subnets across all of the networks in the application do not compromise communication between the correct safety devices.

The SNN is a unique identifier that is automatically assigned to each subnet in a safety application. The same SNN is assigned to also devices on the subnet.

For example, when a FLEX 5000 I/O EtherNet/IP adapter is used in a safety application, the Logix Designer project assigns it an SNN. All FLEX 5000 I/O modules that are installed with that adapter, are automatically assigned the same SNN.

However, each FLEX 5000 safety I/O modules require a unique identifier within the same subnet. A DeviceID is used to uniquely identify each safety module. The SNN and module slot number make up the DeviceID of the safety module.

Set the SNN Manually

The SNN is used to provide integrity on the initial download to a FLEX 5000 I/O safety module.

If a safety signature exists, the FLEX 5000 I/O safety module must have DeviceID that matches the module in the safety controller project, before it can receive its configuration.

To maintain integrity, the module SNN must be set manually.

1. On the General category of the Module Properties dialog box, click the ellipsis next to the Safety Network Number.



2. On the Safety Network Number dialog box, click Manual.

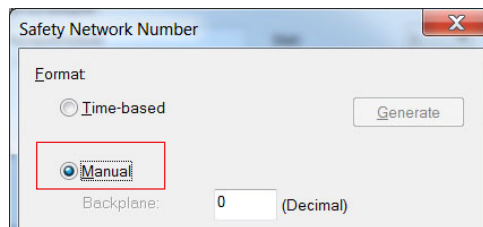

3. Type the SNN in the Number field and click OK.

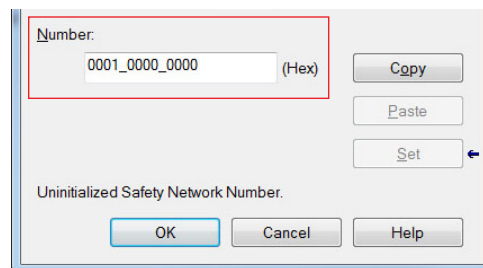

4. On the Module Properties dialog box, click OK.

Reset to Out-of-Box Configuration

When the Logix Designer application is online, the Safety tab of the Module Properties dialog box displays the current configuration ownership. When the opened project owns the configuration, Local is displayed.

When a second device owns the configuration, Remote is displayed, along with the SNN, and node address or slot number of the configuration owner. Communication error is displayed if the module read fails.

If the connection is Local, you must inhibit the module connection before you reset ownership.

To inhibit the module, follow these steps.

1. Right-click the module and choose Properties.
2. On the Connection tab, click Inhibit module.
3. Click Apply and then OK.

Follow these steps to reset the module to its out-of-box configuration when online.

1. Right-click the module and choose Properties.
2. On the Safety tab, click Reset Ownership.

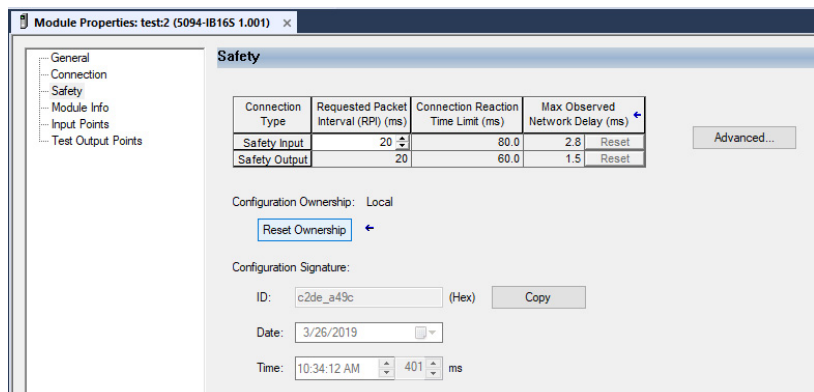

3. When a dialog box appears asking if you want to continue with the reset, read it and click Yes.

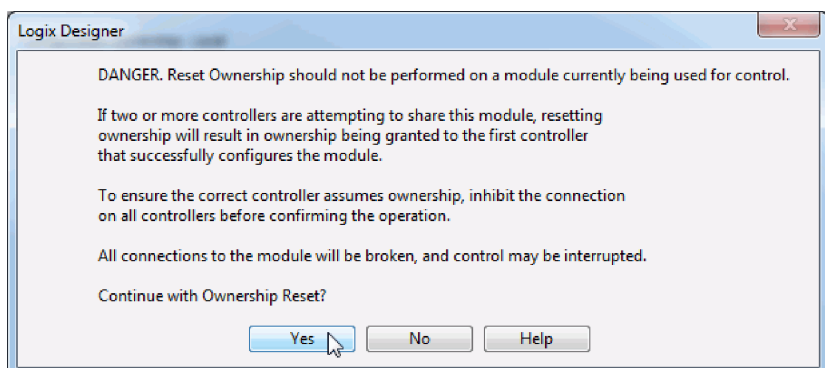

Replace a Module in a Logix 5000 System

Consider the following conditions before you replace a FLEX 5000 safety I/O module in a Logix 5000™ system:

- If you rely on a portion of the CIP Safety system to maintain SIL 3 behavior during module replacement and functional testing, you must use the Configure Only When No Safety Signature Exists feature.
- If you rely on the entire routable CIP Safety control system to maintain SIL 3/PL (*d* or *e*) during the replacement and functional testing of a module, you can use the Configure Always feature.

Replacement with 'Configure Only When No Safety Signature Exists' Enabled

When a module is replaced, the configuration is downloaded from the safety controller if the DeviceID of the new module matches the original. The DeviceID is updated whenever the SNN is set.

If the project is configured with Configure Only When No Safety Signature Exists enabled, follow the appropriate instructions in to replace a FLEX 5000 safety I/O module.

After you complete the steps in a scenario correctly, the DeviceID matches the original. This match enables the safety controller to download the proper module configuration, and re-establish the safety connection.

Table 19 - Replace a FLEX 5000 Safety I/O Module

Controller Safety Signature Exists	Replacement Module Condition	Action Required
No	No SNN (Out-of-box)	None. The module is ready for use.
Yes or No	Same SNN as original safety task configuration	None. The module is ready for use.
Yes	No SNN (Out-of-box)	Complete the steps in Set the SNN Manually on page 119 .
Yes	Different SNN from original safety task configuration	1. Reset to Out-of-Box Configuration on page 120 . 2. Set the SNN Manually on page 119 .
No		1. Reset to Out-of-Box Configuration on page 120 . 2. Follow your company-prescribed procedures to functionally test the replaced I/O device and system and to authorize the system for use.

Replacement with 'Configured Always' Enabled



ATTENTION: Enable the 'Configure Always' feature only if the entire CIP Safety Control System is not being relied on to maintain SIL 3 behavior during the replacement and functional testing of a module.

Do not place modules that are in the out-of-box condition on a CIP Safety network when the Configure Always feature is enabled, except while following this replacement procedure.

When the 'Configure Always' feature is enabled, the controller automatically checks for and connects to a replacement module that meets all the following requirements:

- The controller has configuration data for a compatible module at that network address.
- The module is in out-of-box condition or has an SNN that matches the configuration.

If the project is configured for 'Configure Always', follow the appropriate steps to replace a FLEX 5000 safety I/O module.

1. Remove the old I/O module and install the new module.

If	Then
the module is in out-of-box condition	go to step 6 . No action is needed for the controller to take ownership of the module.
an SNN mismatch error occurs	go to the next step to reset the module to out-of-box condition.

2. Right-click your I/O module and choose Properties.
3. Click the Safety tab.
4. Click Reset Ownership.
5. Click OK.
6. Follow your company-prescribed procedures to functionally test the replaced I/O module and system and to authorize the system for use.

Troubleshoot Your Module

Topic	Page
SA Power Indicator	124
Module Status Indicator	125
FLEX 5000 Digital Input Modules Status Indicators	126
FLEX 5000 Output Modules Status Indicators	127
FLEX 5000 Safety Input Modules Status Indicators	129
FLEX 5000 Safety Output Modules Status Indicators	130
FLEX 5000 Safety Relay Output Modules Status Indicators	131
Use the Logix Designer Application for Troubleshooting	132

FLEX 5000™ I/O modules use the following status indicators:

- SA Power Indicator - This indicator operates the same for all FLEX 5000 I/O modules.
- Module Status Indicator - This indicator operates the same for all FLEX 5000 I/O modules.
- I/O Status Indicator - This indicator operates differently based on the module type.

SA Power Indicator

Table 20 describes the SA Power indicator on FLEX 5000 I/O modules.

Table 20 - SA Power Indicator - FLEX 5000 Standard I/O Modules

Indicator State	Description	Recommended Action
Off	The module is not powered.	Complete the following actions: 1. Confirm that the system is powered. 2. Confirm that the module is installed properly.
Steady green	There is SA power to the module.	None
Steady red	There is no SA power to the module.	Complete the following actions: 1. Confirm that the SA Power wiring on the terminal base is installed properly. 2. Check the following: – Confirm that there is sufficient voltage supplied to the module. – If an external power supply is used, confirm that the power supply is turned on. – If power is daisy chained from the previous terminal base, confirm that the wiring on the previous terminal base is installed properly.

Table 21 - SA Power Indicator - FLEX 5000 Safety I/O Modules

Indicator State	Description	Recommended Action
Off	The module is not powered.	Complete the following actions: 1. Confirm that the system is powered. 2. Confirm that the module is installed properly.
Steady green	There is SA power to the module.	None
Steady red	There is no SA power to the module.	Complete the following actions: 1. Confirm that the SA Power wiring on the terminal base is installed properly. 2. Check the following: – Confirm that there is sufficient voltage supplied to the module. – If an external power supply is used, confirm that the power supply is turned on. – If power is daisy chained from the previous terminal base, confirm that the wiring on the previous terminal base is installed properly.

Module Status Indicator [Table 22](#) describes the Module Status indicator on FLEX 5000 I/O modules.

Table 22 - Module Status Indicator - FLEX 5000 Digital I/O Modules

Indicator State	Description	Recommended Action
Off	The module is not powered.	Complete the following actions: 1. Confirm that the system is powered. 2. Confirm that the module is installed properly.
Steady green	The module has a connection to the owner-controller and is operating normally.	None
Flashing green	One of the following conditions exist: <ul style="list-style-type: none"> The module has powered up successfully. The module is OK, but it does not have a connection. No connection can result from missing, incomplete, or incorrect module configuration. For safety modules only - A connection can be established with the controller, but initial time coordination exchange is not complete. Connection to an output module is in the idle state.	Complete the following actions: <ul style="list-style-type: none"> Troubleshoot your Logix Designer application to determine what is preventing a connection from the module to the controller and correct the issue. Confirm that the system conditions require the controller to be in Remote Run mode or Run mode, transition the controller to one of those modes.
Steady red	The module experienced a nonrecoverable fault.	Complete the following actions: 1. Cycle power to the module. 2. If the status indicator remains in the steady red state, replace the module.
Flashing red	One of the following conditions exist: <ul style="list-style-type: none"> A module firmware update is in progress. A module firmware update attempt failed. The device has experienced a recoverable fault. A connection to the module has timed out. 	Complete one of the following: <ul style="list-style-type: none"> Let the firmware update progress complete. Reattempt a firmware update after one fails. Use the Logix Designer application to determine the cause of the module fault. The Connection and Module Info categories of the modules configuration indicate the fault type. To clear a recoverable fault, complete one of the following: – Cycle module power. – Click Reset Module in the Logix Designer project via the Module Info category of the Module Properties dialog box. If the fault does not clear after cycling power and clicking Reset Module, contact Rockwell Automation Technical Support. <ul style="list-style-type: none"> Use the Logix Designer application to determine if a connection has timed out. The Connection category in the Module Properties for the module indicates the module state, including if a connection has timed out. If a connection has timed out, determine the cause and correct it. For example, a cable failure can cause a connection timeout.
Red/green (railroad)	For safety modules only - This pattern indicates that a UNID for the safety device needs to be configured.	None

FLEX 5000 Digital Input Modules Status Indicators

Figure 16 shows the status indicators on FLEX 5000 input modules.

Figure 16 - FLEX 5000 Input Module Status Indicators

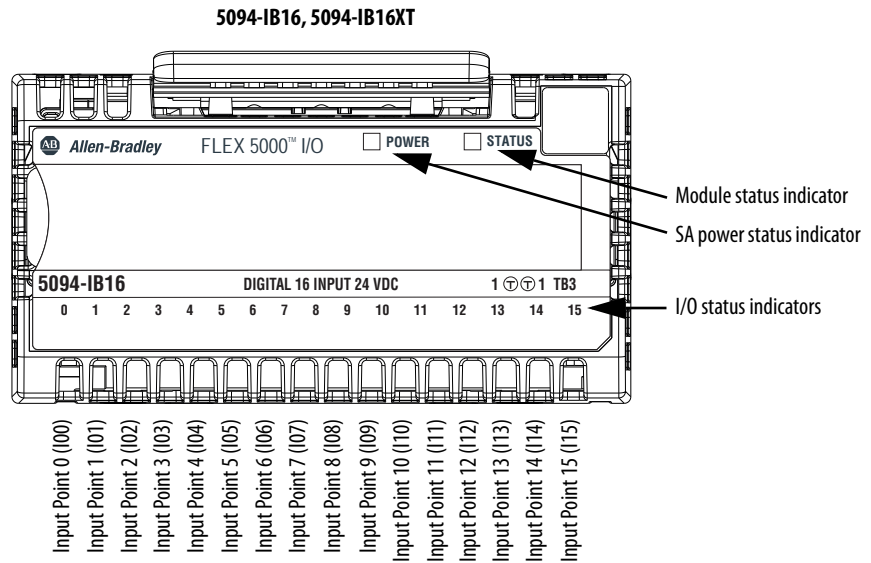

Table 23 describes the I/O Status indicators on FLEX 5000 input modules.

Table 23 - I/O Status Indicators - FLEX 5000 Input Modules

Indicator State	Description	Recommended Action
Off	One of the following: <ul style="list-style-type: none"> The input point is Off. There is no backplane power. 	One of the following: <ul style="list-style-type: none"> Confirm that the input point is configured properly. Confirm that there is backplane power supplied through the FLEX 5000 EtherNet/IP adapter.
Steady yellow	The input point is operating normally.	None
Flashing red	A Field Power Loss condition exists.	Locate and correct the cause of field power loss condition.

FLEX 5000 Output Modules Status Indicators

Figure 17 show the status indicators on FLEX 5000 output modules.

Figure 17 - FLEX 5000 Output Modules Status Indicators

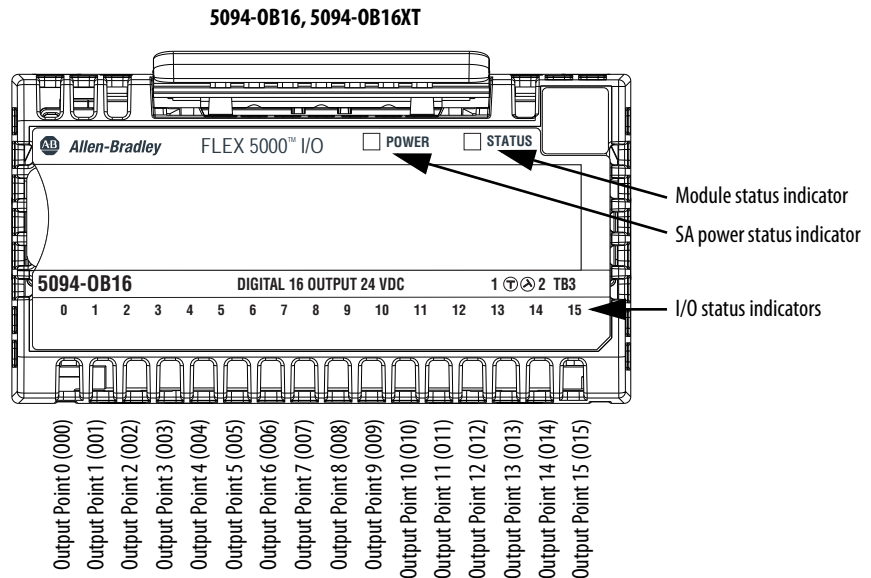

Table 24 describes the I/O Status indicators on FLEX 5000 output modules.

Table 24 - I/O Status Indicators - FLEX 5000 Output Modules

Indicator State	Description	Recommended Action
Off	One of the following: <ul style="list-style-type: none"> The output point is Off. There is no backplane power. 	One of the following: <ul style="list-style-type: none"> Confirm that the output point is configured properly. Confirm that there is backplane power supplied through the FLEX 5000 EtherNet/IP adapter.
Steady yellow	The output point is operating normally.	None
Flashing red	One of the following: <ul style="list-style-type: none"> A No Load or Short Circuit condition is detected. A Field Power Loss condition exists. 	One of the following: <ul style="list-style-type: none"> Locate and correct the cause of No Load or Short Circuit condition. Locate and correct the cause of Field Power Loss condition.

Figure 18 show the status indicators on FLEX 5000 relay output modules.

Figure 18 - FLEX 5000 Relay Output Module Status Indicators

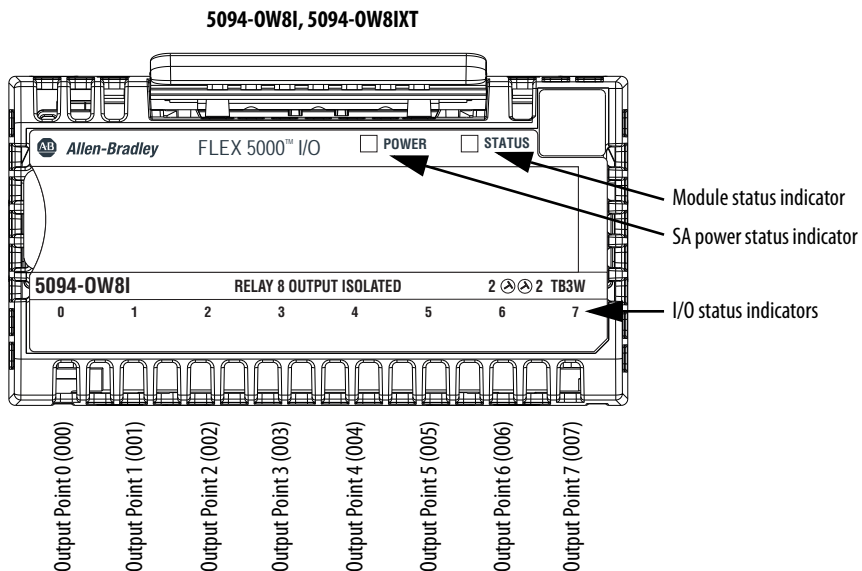

Table 25 describes the I/O Status indicators on FLEX 5000 relay output modules.

Table 25 - I/O Status Indicators - FLEX 5000 Relay Output Modules

Indicator State	Description	Recommended Action
Off	One of the following: <ul style="list-style-type: none"> The output point is Off. There is no backplane power. 	One of the following: <ul style="list-style-type: none"> Confirm that the output point is configured properly. Confirm that there is backplane power supplied through the FLEX 5000 EtherNet/IP adapter.
Steady yellow	The output point is operating normally.	None
Flashing red	A Field Power Loss condition exists.	Locate and correct the cause of field power loss condition.

FLEX 5000 Safety Input Modules Status Indicators

Figure 19 shows the status indicators on FLEX 5000 safety input modules.

Figure 19 - FLEX 5000 Safety Input Modules

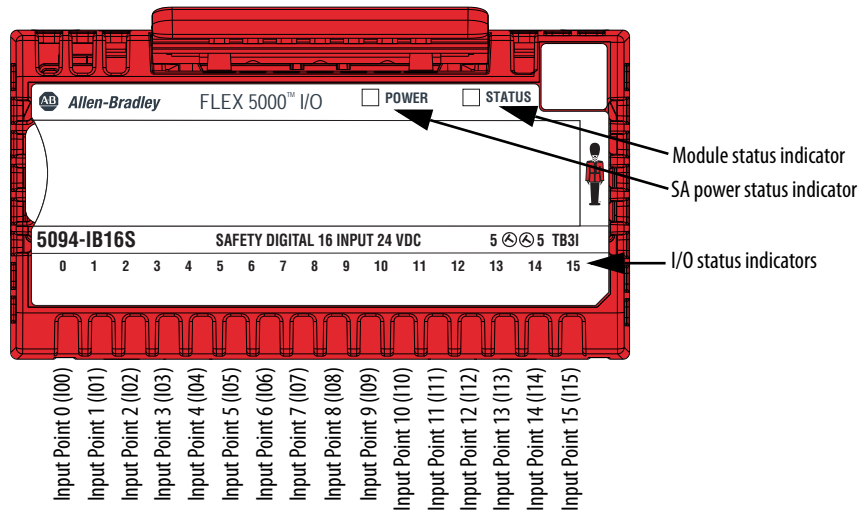

Table 26 - I/O Status Indicators - FLEX 5000 Safety Input Modules

Indicator State	Description	Recommended Action
Off	One of the following: <ul style="list-style-type: none"> The input point is Off. There is no backplane power. 	One of the following: <ul style="list-style-type: none"> Confirm that the input point is configured properly. Confirm that there is backplane power supplied through the FLEX 5000 EtherNet/IP adapter.
Steady yellow	The input point is operating normally.	None
Flashing red	Recoverable faults.	Locate and correct faults.
Steady red	<ul style="list-style-type: none"> A Field Power Loss condition exists. Internal channel fault. 	<ul style="list-style-type: none"> Locate and correct the cause of field power loss condition. Locate and correct the internal fault.

FLEX 5000 Safety Output Modules Status Indicators

Figure 20 shows the status indicators on FLEX 5000 safety output modules.

Figure 20 - FLEX 5000 Safety Output Modules

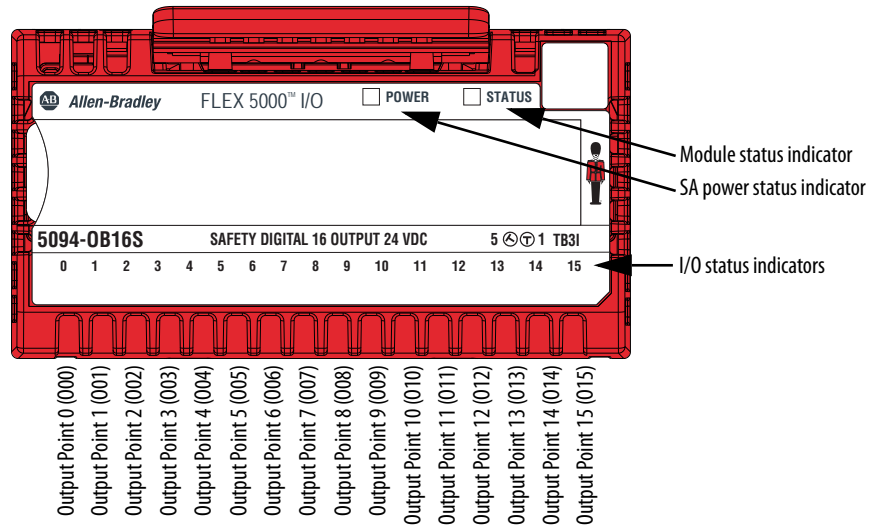

Table 27 - I/O Status Indicators - FLEX 5000 Safety Output Modules

Indicator State	Description	Recommended Action
Off	One of the following: <ul style="list-style-type: none"> The output point is Off. There is no backplane power. 	One of the following: <ul style="list-style-type: none"> Confirm that the output point is configured properly. Confirm that there is backplane power supplied through the FLEX 5000 EtherNet/IP adapter.
Steady yellow	The output point is operating normally.	None
Flashing red	A No Load or Short Circuit condition is detected.	Locate and correct the cause of No Load or Short Circuit condition.
Steady red	One of the following: <ul style="list-style-type: none"> A Field Power Loss condition exists. Internal channel fault. 	One of the following: <ul style="list-style-type: none"> Locate and correct the cause of field power loss condition. Locate and correct the internal fault.

FLEX 5000 Safety Relay Output Modules Status Indicators

Figure 20 shows the status indicators on FLEX 5000 safety relay output modules.

Figure 21 - FLEX 5000 Safety Relay Output Modules

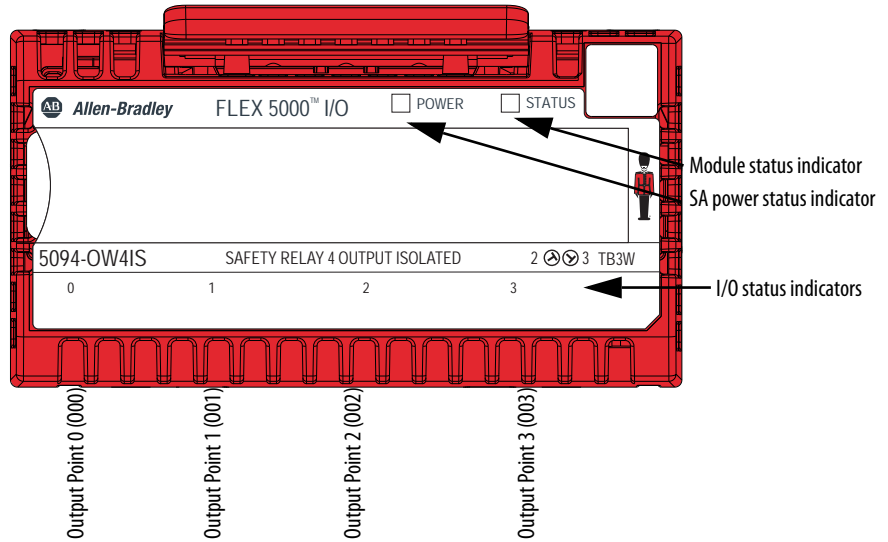
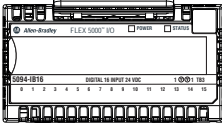

Table 28 - I/O Status Indicators - FLEX 5000 Safety Relay Output Modules

Indicator State	Description	Recommended Action
Off	One of the following: <ul style="list-style-type: none"> The output point is Off. There is no backplane power. 	One of the following: <ul style="list-style-type: none"> Confirm that the output point is configured properly. Confirm that there is backplane power supplied through the FLEX 5000 EtherNet/IP adapter.
Steady yellow	The output point is operating normally.	None
Steady red	One of the following: <ul style="list-style-type: none"> A Field Power Loss condition exists. Internal channel fault. 	One of the following: <ul style="list-style-type: none"> Locate and correct the cause of Field Power Loss condition. Locate and correct internal fault.

Use the Logix Designer Application for Troubleshooting

Standard Modules



Safety Modules

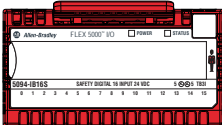

In addition to the status indicator display on the module, the Logix Designer application indicates the presence of fault conditions.

Fault conditions are reported in the following ways:

- [Warning Signal in the I/O Configuration Tree](#)
- [Status and Fault Information in Module Properties Categories](#)
- [Logix Designer Application Tag Editor](#)

Warning Signal in the I/O Configuration Tree

As shown in [Figure 22](#), a warning icon appears in the I/O Configuration tree when a fault occurs.

Figure 22 - Warning Icon in Controller Organizer

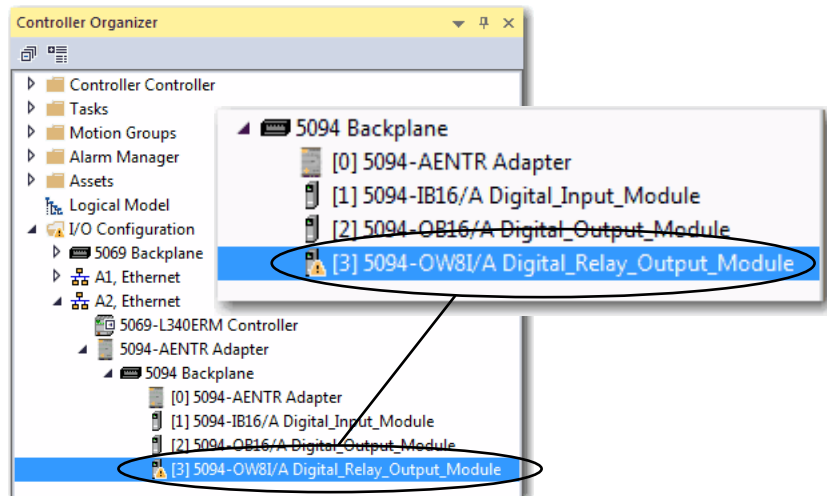

Status and Fault Information in Module Properties Categories

The Module Properties section in the Logix Designer application includes a series of categories. The numbers and types of categories varies by module type.

Each category includes options to configure the module or monitor the status of the module. The following are ways to monitor the state of a module for faults:

- [Module Status on General Category](#)
- [Module Fault Descriptions on Connection Category](#)
- [Module Fault Descriptions on Module Info Category](#)
- [Module Diagnostics Dialog Box](#)
- [Point Diagnostics](#)

Module Status on General Category

As shown in [Figure 23](#), the status of a module is indicated on the General category of the Modules Properties.

Figure 23 - Fault Message in Status Line

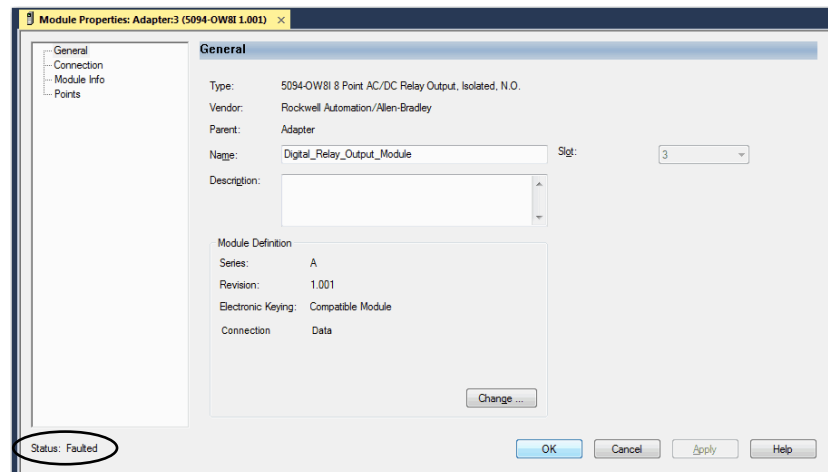

Module Fault Descriptions on Connection Category

As shown in [Figure 24](#), a module fault description that includes an error code that is associated with the specific fault type is listed on the Connection category.

Figure 24 - Fault Description with Error Code

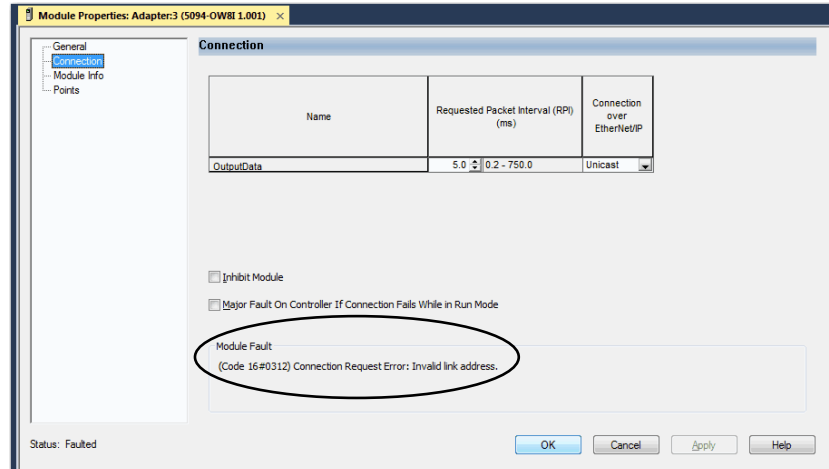

Module Fault Descriptions on Module Info Category

As shown in [Figure 25](#), major and minor fault information is listed on the Module Info category.

Figure 25 - Major and Minor Fault Information

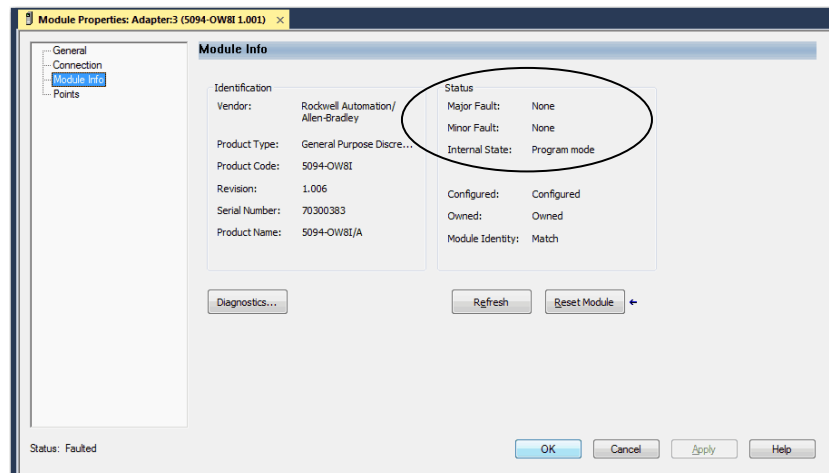

Module Diagnostics Dialog Box

Module Diagnostics are accessible from the Module Info category on the Module Properties dialog box, as shown in [Figure 26](#).

You can use diagnostics in a Logix Designer project to monitor module operating conditions and to troubleshoot issues that affect a module. You can use diagnostics only when the **project is online**.

Module diagnostics provide information on a module-wide basis. For example, the Module Diagnostics dialog box indicates the mode within which a module is operating, that is, Run, Remote Run, Remote Program, or Program.

Figure 26 - Module Diagnostics

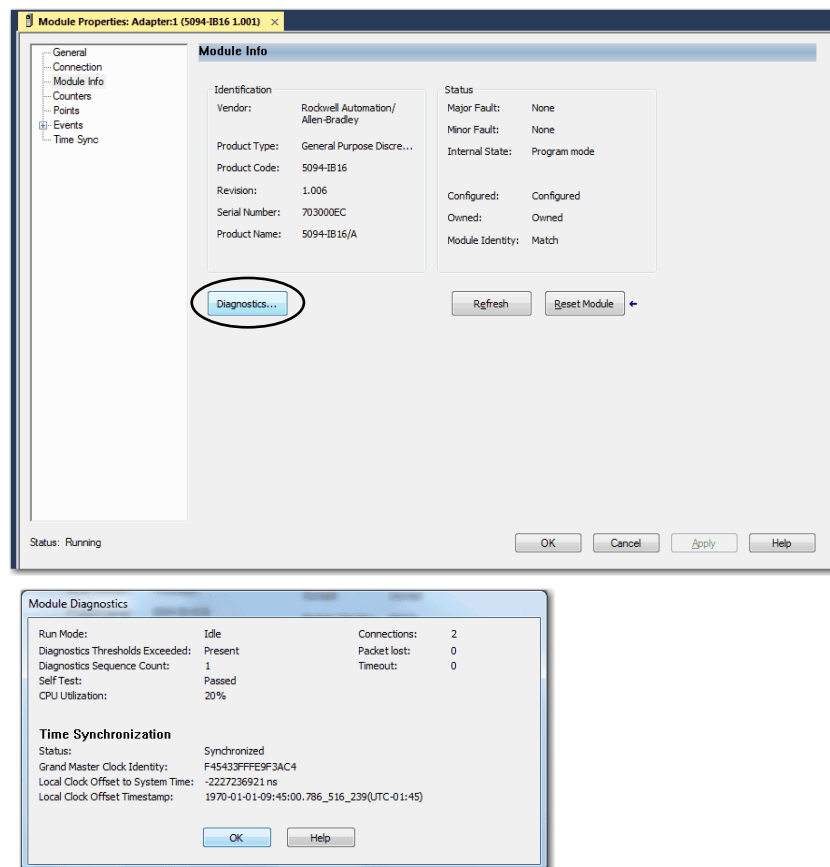

Point Diagnostics

You can use diagnostics in a Logix Designer project to monitor module and/or point operating conditions and to troubleshoot issues that affect a module and/or point. You can use diagnostics only when the **project is online**.

Point diagnostics provide information on an individual point basis. For example, you can check individual points on a 5094-IB16S or 5094-IB16SXT safety input module for the presence of a Short Circuit condition.

Remember the following:

- Not all FLEX 5000 I/O digital modules provide point diagnostics.
- The point diagnostics that are available vary by module type and functionality.
- There are some differences between modules, but most commonly, the Module Properties dialog box category from which you can access point diagnostics is Points.

[Figure 27](#) shows how to access output point diagnostics on the 5094-OB16S module and the diagnostics dialog box.

Figure 27 - Point Diagnostics

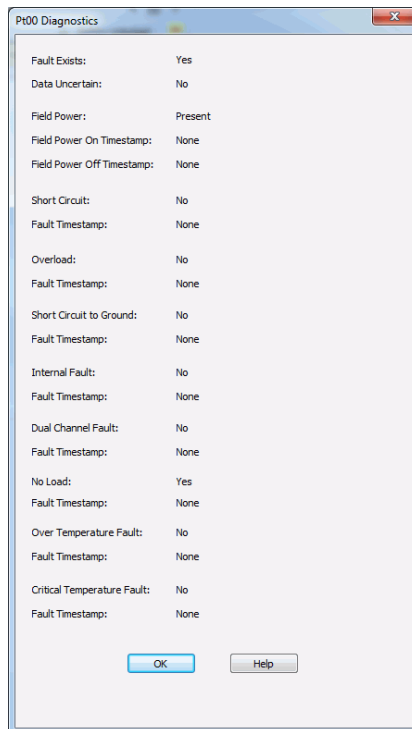

Logix Designer Application Tag Editor

Figure 28 show how fault conditions are indicated in the controller tags for the module.

Figure 28 - Fault Indication in Controller Tags

Name	Value	Force Mask	Style	Data Type
▶ Adapter1:C	{...}	{...}	{...}	AB:5000_DII6_Diag_Ti...
▶ Adapter1:EI	{...}	{...}	{...}	AB:5000_DII6_Event4:...
▶ Adapter1:EO	{...}	{...}	{...}	AB:5000_DII6_Event4:...
▲ Adapter1:I	{...}	{...}	{...}	AB:5000_DII6_Timest...
Adapter1:I.RunMode	0		Decimal	BOOL
Adapter1:I.ConnectionFaulted	1		Decimal	BOOL
Adapter1:I.DiagnosticActive	0		Decimal	BOOL
Adapter1:I.CIPSyncValid	0		Decimal	BOOL
Adapter1:I.CIPSyncTimeout	0		Decimal	BOOL
▶ Adapter1:I.DiagnosticSequenceCount	0		Decimal	SINT
▲ Adapter1:I.Pt00	{...}	{...}	{...}	CHANNEL_DI.TIMES...
Adapter1:I.Pt00.Data	0		Decimal	BOOL
Adapter1:I.Pt00.Fault	1		Decimal	BOOL
Adapter1:I.Pt00.Uncertain	0		Decimal	BOOL
Adapter1:I.Pt00.Chatter	0		Decimal	BOOL
Adapter1:I.Pt00.TimestampOverflowOffOn	0		Decimal	BOOL
Adapter1:I.Pt00.TimestampOverflowOnOff	0		Decimal	BOOL
Adapter1:I.Pt00.CIPSyncValid	0		Decimal	BOOL
Adapter1:I.Pt00.CIPSyncTimeout	0		Decimal	BOOL

Notes:

Module Tag Definitions

Topic	Page
Tag Name Conventions	140
Access the Tags	140
5094-IB16 Module Tags	141
5094-IB16S Module Tags	149
5094-OB16 Module Tags	151
5094-OB16S Module Tags	154
5094-OW4IS Module Tags	156
5094-OW8I Module Tags	157

Module tags are created when you add a module to the Logix Designer application project. XT and non-XT modules use the same module tag definitions. For instance, the 5094-OB16SXT module uses the same module tag definitions as the 5094-OB16S module.

The set of module tags associated with a module depends on the module type and Module Definition choices made during module configuration. For example, if you use a Listen Only Connection, the Logix Designer application creates only Input tags for that module.

The following types of tags are available with FLEX 5000™ I/O modules:

- Configuration
- Event Input - 5094-IB16 and 5094-IB16XT modules only
- Event Output - 5094-IB16 and 5094-IB16XT modules only
- Input
- Output

The tables contained in this section list all of the tags available with a module. Not all tags in the list are used when that module type is added to a project. Tag use varies by module configuration.

Tag Name Conventions

Standard Modules

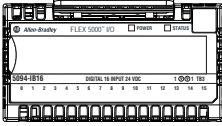

Safety Modules

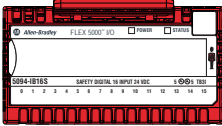

The module tag names use defined naming conventions. The conventions are as follows:

Example tag name = Adapter1:I.Pt00.Data

- Adapter = name of the FLEX 5000 EtherNet/IP adapter in the FLEX 5000 I/O system
- 1 = slot number
- I = tag type

The possible FLEX 5000 I/O tag types are C (configuration), EI (event input), EO (event output), I (input), and O (output)

- Pt00 = module point number
- Data = tag function

In this case, Data represents the input data that is returned to the owner-controller.

Access the Tags

Standard Modules

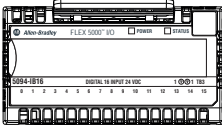

Safety Modules

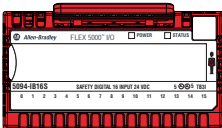

You view tags from the Tag Editor.

1. Open your Logix Designer application project.
2. Right-click Controller Tags and choose Monitor Tags.

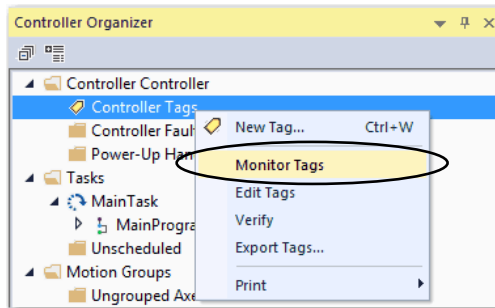

3. Open the tags as necessary to view specific tags.

Name	Value	Force Mask	Style	Data Type
Adapter1:C	(...)	(...)	(...)	AB:5000_D16_Diag_Timestamp:C:0
Adapter1:C.Pt00	(...)	(...)	(...)	AB:5000_DI_Diag_Timestamp_Channel:C:0
Adapter1:C.Pt01	(...)	(...)	(...)	AB:5000_DI_Diag_Timestamp_Channel:C:0
Adapter1:C.Pt01.InputOffOnFilter	5		Decimal	SINT
Adapter1:C.Pt01.InputOffOnFilter.0	1		Decimal	BOOL
Adapter1:C.Pt01.InputOffOnFilter.1	0		Decimal	BOOL
Adapter1:C.Pt01.InputOffOnFilter.2	1		Decimal	BOOL
Adapter1:C.Pt01.InputOffOnFilter.3	0		Decimal	BOOL
Adapter1:C.Pt01.InputOffOnFilter.4	0		Decimal	BOOL
Adapter1:C.Pt01.InputOffOnFilter.5	0		Decimal	BOOL
Adapter1:C.Pt01.InputOffOnFilter.6	0		Decimal	BOOL
Adapter1:C.Pt01.InputOffOnFilter.7	0		Decimal	BOOL

5094-IB16 Module Tags

This section describes the tags that are associated with the 5094-IB16 module.

Standard Modules

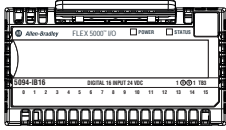

Configuration Tags

[Table 29](#) describes the 5094-IB16 module configuration tags.

Table 29 - 5094-IB16 Module Configuration Tags

Name	Data Type	Definition	Valid Values
Counterxx.InputOffOnFilter	SINT	The amount of time that a signal must be in the on state before the input data indicates the on state. The amount of time is indicated using an enumeration. Not all products support all enumeration values.	<ul style="list-style-type: none"> • 9 = 0 μs • 10 = 100 μs • 11 = 200 μs • 12 = 500 μs • 13 = 1 ms • 14 = 2 ms • 15 = 5 ms • 16 = 10 ms • 17 = 20 ms • 18 = 50 ms
Counterxx.InputOnOffFilter	SINT	The amount of time that a signal must be in the off state before the input data indicates the off state. The amount of time is indicated using an enumeration. Not all products support all enumeration values.	<ul style="list-style-type: none"> • 9 = 0 μs • 10 = 100 μs • 11 = 200 μs • 12 = 500 μs • 13 = 1 ms • 14 = 2 ms • 15 = 5 ms • 16 = 10 ms • 17 = 20 ms • 18 = 50 ms
FieldPowerDiagEN	BOOL	Determines whether the point faults when no field power is present. <ul style="list-style-type: none"> • If the input is powered from the SA, select this checkbox to monitor the status of the SA power. • If the input is powered from another power supply, do not select this checkbox, so that the input continues to work even when there is no SA power 	<ul style="list-style-type: none"> • 0 = Field Power/SA Power Diagnostics is not sent to the controller. • 1 = Field Power/SA Power Diagnostics is sent to the controller. Use this if the sensor uses the SA power in the terminal base.
Counterxx.RolloverAtPreset	BOOL	Determines whether the simple counter will rollover to 0 when it reaches 0:Preset (1) or at 2147483647 (0).	<ul style="list-style-type: none"> • 0 = Maximum value • 1 = Preset value
Ptxx.InputOffOnFilter	SINT	The amount of time that a signal must be in the on state before the input data indicates the on state. The amount of time is indicated using an enumeration. Not all products support all enumeration values. Ptxx depends on the number of counters that have been configured.	<ul style="list-style-type: none"> • 9 = 0 μs • 10 = 100 μs • 11 = 200 μs • 12 = 500 μs • 13 = 1 ms • 14 = 2 ms • 15 = 5 ms • 16 = 10 ms • 17 = 20 ms • 18 = 50 ms
Ptxx.InputOnOffFilter	SINT	The amount of time that a signal must be in the off state before the input data indicates the off state. The amount of time is indicated using an enumeration. Not all products support all enumeration values. Ptxx depends on the number of counters that have been configured.	<ul style="list-style-type: none"> • 9 = 0 μs • 10 = 100 μs • 11 = 200 μs • 12 = 500 μs • 13 = 1 ms • 14 = 2 ms • 15 = 5 ms • 16 = 10 ms • 17 = 20 ms • 18 = 50 ms

Table 29 - 5094-IB16 Module Configuration Tags

Name	Data Type	Definition	Valid Values
Ptxx.ChatterTime	INT	A value from 1...10000 ms in whole ms increments.	1...10000
Ptxx.ChatterCount	SINT	The number of input changes that are considered Chatter.	<ul style="list-style-type: none"> 0 = Disabled 2...127 = Enabled
Ptxx.CaptureOffOnEn	BOOL	Enables capturing Off to On time stamps. If cleared, the point does not record Off to On time stamps.	<ul style="list-style-type: none"> 0 = Capture disabled for OFF to ON input transitions 1 = Capture enabled (default) for OFF to ON input transitions
Ptxx.CaptureOnOffEn	BOOL	Enables capturing On to Off time stamps. If cleared, the point does not record On to Off time stamps.	<ul style="list-style-type: none"> 0 = Capture disabled for ON to OFF input transitions 1 = Capture enabled (default) for ON to OFF input transitions
Ptxx.TimestampLatchEn	BOOL	<p>When this bit is set, timestamps are latched; this means that a Timestamp is not overwritten until acknowledged. All subsequent transitions on that point are ignored until acknowledged/reset. If the bit is not set, the new LO Timestamp overwrites the first LO Timestamp immediately, even if the controller has yet to extract that data.</p> <p>Timestamp can also be acknowledged by writing I:TimestampxxNumber to O:TimestampxxNumberAck. This clears the I:Timestampxx and I:TimestampOverflowxx (where xx = OnOff or OffOn).</p>	<ul style="list-style-type: none"> 0 = Timestamps are overridden with each successive COS transition. 1 = Timestamps are latched until acknowledged.

Input Tags

[Table 30](#) describes the 5094-IB16 module input tags.

Table 30 - 5094-IB16 Module Input Tags

Name	Data Type	Definition	Valid Values
RunMode	BOOL	The point's operating state	<ul style="list-style-type: none"> 0 = Idle 1 = Run
ConnectionFaulted	BOOL	Indicates if a connection is running. The module sets this tag to 0 when connected. If the module is not connected, it changes the tag to 1.	<ul style="list-style-type: none"> 0 = Good 1 = Bad
DiagnosticActive	BOOL	Indicates if any diagnostics are active or if the prognostics threshold is reached.	<ul style="list-style-type: none"> 0 = No diagnostics active 1 = One or more diagnostics are active or the prognostics threshold is reached
CIPSyncValid	BOOL	Indicates whether the module is synced with a 1588 master.	<ul style="list-style-type: none"> 0 = CIP Sync™ is not available 1 = CIP Sync is available
CIPSyncTimeout	BOOL	Indicates that the module was once synced with a 1588 master, but is not now due to a timeout.	<ul style="list-style-type: none"> 0 = A valid time master has not timed out 1 = A valid time master was detected on the backplane, but the time master has timed out. The module is using its local clock and can be drifting away from the last known master time.
DiagnosticSequenceCount	SINT	<p>Increments for each time a distinct diagnostic condition is detected, and when a distinct diagnostic condition transitions from detected to not detected.</p> <p>Set to zero by product reset or power cycle. Wraps from 255 (-1) to 1 skipping zero.</p>	<p>-128...+127</p> <p>The value of 0 is skipped except during module powerup.</p>
Counterxx.Data	BOOL	Indicates the current digital input value.	<ul style="list-style-type: none"> 0 = Off 1 = On

Table 30 - 5094-IB16 Module Input Tags

Name	Data Type	Definition	Valid Values
Counterxx.Fault	BOOL	Indicates that counter data is inaccurate and cannot be trusted for use in the application. For more information, see Module Data Quality Reporting on page 47 .	<ul style="list-style-type: none"> 0 = Good 1 = Bad, causing fault If the tag is set to 1, you must troubleshoot the module to correct the cause of the inaccuracy. IMPORTANT: Once the condition that causes the tag to change to 1 is removed, the tag automatically resets to 0.
Counterxx.Uncertain	BOOL	Indicates that the counter data can be inaccurate but the degree of inaccuracy is not known. For more information, see Module Data Quality Reporting on page 47 .	<ul style="list-style-type: none"> 0 = Good data 1 = Uncertain data If the tag is set to 1, you must troubleshoot the module to correct the cause of the inaccuracy. IMPORTANT: Once the condition that causes the tag to change to 1 is removed, the tag automatically resets to 0.
Counterxx.Done	BOOL	When set, indicates the corresponding counter Done bit (rising or falling depending on configuration) triggered the event.	<ul style="list-style-type: none"> 0 = Corresponding Done bit did not trigger the event 1 = Corresponding Done bit triggered the event
Counterxx.Rollover	BOOL	The counter counted up to Preset - 1 and continued counting from 0. The 0:RolloverAck bit transitioning from 0 to 1 or the 0:Reset transitioning from 0 to 1 clears this bit.	<ul style="list-style-type: none"> 0 = Counter has not counted up to Preset - 1 1 = Counter counted up to Preset - 1 and continued counting from 0.
Counterxx.Count	DINT	The number of input transitions counted by a counter.	All values.
EventStatus[x].CIPSyncValid	BOOL	Indicates whether the module is synced with a 1588 master.	<ul style="list-style-type: none"> 0 = CIP Sync is not available 1 = CIP Sync is available
EventStatus[x].CIPSyncTimeout	BOOL	Indicates that the module was once synced with a 1588 master, but is not now due to a timeout.	<ul style="list-style-type: none"> 0 = A valid time master has not timed out 1 = A valid time master was detected on the backplane, but the time master has timed out. The module is using its local clock and can be drifting away from the last known master time.
EventStatus[x].EventDropped	BOOL	Indicates when an event has been discarded because events are occurring faster than they are being acknowledged.	<ul style="list-style-type: none"> 0 = An event status has not been dropped 1 = An event status has been dropped
EventStatus[x].EventReset	BOOL	When E0.Event[<n>].ResetEvent transitions from 0 to 1, I.EventStatus[<n>].EventReset transitions to 1 to indicate that the reset was received and completed. It stays 1 until E0.Event[<n>].ResetEvent transition to zero.	<ul style="list-style-type: none"> 0 = Do not reset 1 = Reset
EventStatus[x].EventsPending	SINT	The number of events currently queued in the modules. A value greater than zero indicates that the controller is not currently keeping up with the rate of events.	All positive values.
EventStatus[x].EventNumber	DINT	Running count of events, which increments by one each new time event. The originator sets the Event Number Ack to the Event Number to acknowledge receipt of the event. When the EventNumber reaches its maximum value and rolls over it is to roll over to 1, not 0.	All values.
Ptxx.Data	BOOL	Indicates the current digital input value.	<ul style="list-style-type: none"> 0 = Off 1 = On
Ptxx.Fault	BOOL	Indicates that point data is inaccurate and cannot be trusted for use in the application. For more information, see Module Data Quality Reporting on page 47 .	<ul style="list-style-type: none"> 0 = Good 1 = Bad, causing fault If the tag is set to 1, you must troubleshoot the module to correct the cause of the inaccuracy. IMPORTANT: Once the condition that causes the tag to change to 1 is removed, the tag automatically resets to 0.

Table 30 - 5094-IB16 Module Input Tags

Name	Data Type	Definition	Valid Values
Ptxx.Uncertain	BOOL	Indicates that the point data can be inaccurate but the degree of inaccuracy is not known. For more information, see Module Data Quality Reporting on page 47 .	<ul style="list-style-type: none"> • 0 = Good data • 1 = Uncertain data If the tag is set to 1, you must troubleshoot the module to correct the cause of the inaccuracy. IMPORTANT: Once the condition that causes the tag to change to 1 is removed, the tag automatically resets to 0.
Ptxx.Chatter	BOOL	Indicates if the input is chattering per the ChatterTime and ChatterCount settings.	<ul style="list-style-type: none"> • 0 = Normal • 1 = Input is chattering
Ptxx.TimestampOverflowOffOn	BOOL	Indicates an Off to On time stamp was lost in a discrete product. If TimestampLatchEn is set then a new time stamp was not recorded because one is already latched. If TimestampLatchEn is clear a timestamp was overwritten.	0 or 1
Ptxx.TimestampOverflowOnOff	BOOL	Indicates an On to Off time stamp was lost in a discrete product. If TimestampLatchEn is set then a new time stamp was not recorded because one is already latched. If TimestampLatchEn is clear a timestamp was overwritten.	0 or 1
Ptxx.CIPSyncValid	BOOL	Indicates whether the module is synced with a 1588 master.	<ul style="list-style-type: none"> • 0 = CIP Sync is not available • 1 = CIP Sync is available
Ptxx.CIPSyncTimeout	BOOL	Indicates that the module was once synced with a 1588 master, but is not now due to a timeout.	<ul style="list-style-type: none"> • 0 = A valid time master has not timed out. • 1 = A valid time master was detected on the backplane, but the time master has timed out. The module is using its local clock and can be drifting away from the last known time master.
Ptxx.TimestampOffOnNumber	INT	An Off to On timestamp identifier for the currently produced timestamp.	All values.
Ptxx.TimestampOnOffNumber	INT	An On to Off timestamp identifier for the currently produced timestamp.	All values.
Ptxx.TimestampOffOn	LINT	64 bit Timestamp corresponding to when a change of state Off to On was recorded at the input.	All values.
Ptxx.TimestampOnOff	LINT	64 bit Timestamp corresponding to when a change of state On to Off was recorded at the input.	All values.

Output Tags

[Table 31](#) describes the 5094-IB16 module output tags. The 5094-IB16 module output tags are only available if you have enabled counters in the Module Definition dialog box.

Table 31 - 5094-IB16 Module Output Tags

Name	Data Type	Definition	Valid Values
Counterxx.Reset	BOOL	When this bit transitions from 0 to 1 I:Count and I:Rollover are set to zero.	<ul style="list-style-type: none"> 0 = I:Count and I:Rollover values are not set to 0 1 = I:Count and I:Rollover values are set to 0
Counterxx.RolloverAck	BOOL	Clears the Rollover bit in the input tag when it transitions from 0 to 1.	<ul style="list-style-type: none"> 0 = I:Rollover bit is not cleared 1 = I:Rollover bit is cleared
Counterxx.Preset	DINT	<ul style="list-style-type: none"> If RolloverAtPreset is set, the counter counts to the Preset value and then rolls over to zero. If RolloverAtPreset is not set, the counter sets the Done bit and continues counting up to Max DINT. If C:RolloverAtPreset = 1, then if I:Count ≥ 0:Preset, I:Count=0, else I:Done bit always = 0. Set I:Rollover bit when I:Count transitions from 0:Preset – 1 to 0. If C:RolloverAtPreset = 0, then if I:Count ≥ 0:Preset, I:Done = 1, else I:Done = 0. Set I:Rollover bit when I:Count transitions from 2,147,483,647 to 0. 	0...2,147,483,647
Pttx.ResetTimestamps	BOOL	Erases all recorded timestamps for the input point when it transitions from 0 to 1.	<ul style="list-style-type: none"> 0 = Timestamps are not erased 1 = Timestamps are erased
Pttx.TimestampOffOnNumberAck	INT	An Off to On timestamp identifier that is written by the controller to indicate that the identified timestamp has been seen and acted on. When Latching is enabled and the Timestamp Number that is received from the controller matches the most recent timestamp that is produced, the module is then allowed to produce a new timestamp.	All values.
Pttx.TimestampOnOffNumberAck	INT	An On to Off timestamp identifier that is written by the controller to indicate that the identified timestamp has been seen and acted on. When Latching is enabled and the Timestamp Number that is received from the controller matches the most recent timestamp that is produced, the module is then allowed to produce a new timestamp.	All values.

Event Input Tags

Table 32 describes the 5094-IB16 module event input tags. The event input tags are displayed only if Data with Events is selected in the Module Definition window.

Table 32 - 5094-IB16 Module Event Input Tags

Name	Data Type	Definition	Valid Values
RunMode	BOOL	The point's operating state	<ul style="list-style-type: none"> 0 = Idle 1 = Run Mode
ConnectionFaulted	BOOL	Indicates if a connection is running. The module sets this tag to 0 when connected. If the module is not connected, it changes the tag to 1.	<ul style="list-style-type: none"> 0 = Connection running 1 = Connection not running
Diagnostic Active	BOOL	Indicates if any diagnostics are active or if the prognostics threshold is reached.	<ul style="list-style-type: none"> 0 = No diagnostics active 1 = One or more diagnostics are active or the prognostics threshold is reached
DiagnosticSequence Count	SINT	Increments for each time a distinct diagnostic condition is detected, and when a distinct diagnostic condition transitions from detected to not detected. Set to zero by product reset or power cycle. Wraps from 255 (-1) to 1 skipping zero.	-128...+127 The value of 0 is skipped except during module powerup.
Eventx	BOOL	Indicates the number of the event.	0...3
Eventx.PtxxFault	BOOL	Indicates that point data is inaccurate and cannot be trusted for use in the application. For more information, see Module Data Quality Reporting on page 47 .	<ul style="list-style-type: none"> 0 = Good 1 = Bad, causing fault <p>If the tag is set to 1, you must troubleshoot the module to correct the cause of the inaccuracy.</p> <p>IMPORTANT: Once the condition that causes the tag to change to 1 is removed, the tag automatically resets to 0.</p>
Eventx.Uncertain	BOOL	Indicates that the point data can be inaccurate but the degree of inaccuracy is not known. For more information, see Module Data Quality Reporting on page 47 .	<ul style="list-style-type: none"> 0 = Good data 1 = Uncertain data <p>If the tag is set to 1, you must troubleshoot the module to correct the cause of the inaccuracy.</p> <p>IMPORTANT: Once the condition that causes the tag to change to 1 is removed, the tag automatically resets to 0.</p>
Eventx.EventDropped	BOOL	Indicates when an event has been discarded because events are occurring faster than they are being acknowledged.	<ul style="list-style-type: none"> 0 = An event status has not been dropped. 1 = An event status has been dropped.
Eventx.EventRising	BOOL	Indicates whether an event triggered when an input transition results in an event pattern being matched.	0 or 1
Eventx.EventFalling	BOOL	Indicates whether an event triggered when an input transition resulted in an event pattern no longer being matched.	0 or 1
Eventx.CIPSyncValid	BOOL	Indicates whether the module is synced with a 1588 master.	<ul style="list-style-type: none"> 0 = CIP Sync is not available 1 = CIP Sync is available
Eventx.CIPSyncTimeout	BOOL	Indicates that the module was once synced with a 1588 master, but is not now due to a timeout.	<ul style="list-style-type: none"> 0 = A valid time master has not timed out. 1 = A valid time master was detected on the backplane, but the time master has timed out. The module is using its local clock and can be drifting away from the last known time master.
Eventx.EventsPending	SINT	The number of events currently queued in the modules. A value greater than 0 indicates that the controller is not currently keeping up with the rate of events.	All positive values.

Table 32 - 5094-IB16 Module Event Input Tags

Name	Data Type	Definition	Valid Values
Eventx.EventNumber	DINT	Running count of events, which increments by one each new time event. The originator sets the Event Number Ack to the Event Number to acknowledge receipt of the event. When the EventNumber reaches its maximum value and rolls over it is to roll over to 1, not 0.	All values.
Eventx.EventTimestamp	LINT	The time the event occurred.	All positive values.
Eventx.CounterxxDone	BOOL	When set, indicates the corresponding counter Done bit (rising or falling depending on configuration) triggered the event.	<ul style="list-style-type: none"> • 0 = Corresponding counter Done bit did not trigger the event • 1 = Corresponding counter Done bit triggered the event
Eventx.PtxData	BOOL	When set, indicates the corresponding data value (rising or falling depending on configuration) triggered the event.	<ul style="list-style-type: none"> • 0 = Corresponding data value did not trigger the event • 1 = Corresponding data value triggered the event
Eventx.CounterxxFault	BOOL	When set, indicates that the corresponding counter had a fault indicated when the event occurred.	<ul style="list-style-type: none"> • 0 = Corresponding counter did not have a fault indicated when the event occurred • 1 = Corresponding counter did have a fault indicated when the event occurred
Eventx.Fault	BOOL	Detects whether the signal is good data. The fault is set to 1 by the originator when the connection is lost.	<ul style="list-style-type: none"> • 0 = Good • 1 = Bad

Event Output Tags

Table 33 describes the 5094-IB16 module event output tags. The event output tags are displayed only if Data with Events is selected in the Module Definition window.

Table 33 - 5094-IB16 Module Event Output Tags

Name	Data Type	Definition	Valid Values
Eventxx.En	BOOL	When set, the corresponding event trigger definition is active and events are triggered when conditions match the definition.	<ul style="list-style-type: none"> 0 = Event trigger definition is not active and events are not triggered when conditions match the definition 1 = Event trigger definition is active and events are triggered when conditions match the definition
Eventxx.EventRisingEn	BOOL	When set an event is to trigger each time a condition change results in conditions that match the event trigger definition.	When Enable Independent Point Triggers = Checked (EventRisingEn, EventFallingEn) <ul style="list-style-type: none"> Disable (0,0) On transition (1, 0) On inverted transition (0, 1) On any transition (1, 1)
Eventxx.EventFallingEn	BOOL	When set an event is to trigger each time a condition change results in conditions that no longer match the event trigger definition.	When Enable Independent Point Triggers = Unchecked (EventRisingEn, EventFallingEn) <ul style="list-style-type: none"> Disable (0, 0) On input transition to match pattern (1, 0) On input transition to not match pattern (0, 1) On input transition to match or not match pattern (1, 1)
Eventxx.LatchEn	BOOL	When set, events are latched until acknowledged. A new event is lost if the previous event has not been acknowledged. When not set, new events overwrite old events.	<ul style="list-style-type: none"> 0 = Not latched (default) 1 = Latched
Eventxx.ResetEvent	BOOL	When transitions from 0 to 1, resets all events and clears the event queue on the point.	<ul style="list-style-type: none"> 0 = Events are not cleared. 1 = Events are cleared when a rising edge occurs.
Eventxx.IndependentConditionTriggerEn	BOOL	For events, determines whether each condition that is indicated in the trigger definition can initiate an event independently.	<ul style="list-style-type: none"> 0 = When all selected conditions achieve the configured values, an event is triggered. 1 = When any selected condition achieves the configured value, an event is triggered.
Eventxx.EventNumberAck	DINT	The controller writes back the EI:Event[<n>].EventNumber into this EO:Event[<n>].EventNumberAck to indicate receipt of the event. All events with I:EventNumbers that occurred before EventNumberAck is acknowledged.	All values.
Eventxx.CounterxxSelect	BOOL	When set, indicates that the corresponding counter is to participate in the event trigger definition.	0 = Corresponding counter does not participate in the event trigger definition 1 = Corresponding counter participates in the event trigger definition
Eventxx.PtxxDataSelect	BOOL	When set, indicates that the corresponding data value is to participate in the event trigger definition.	0 or 1
Eventxx.CounterxxValue	BOOL	If the counter function is selected in the event trigger definition, this member indicates that value that is to trigger the event.	0 or 1
Eventxx.PtxxDataValue	BOOL	Indicates the input value of the event point data.	<ul style="list-style-type: none"> 0 = Input inactive 1 = Input active

5094-IB16S Module Tags

This section describes the tags that are associated with the 5094-IB16S module.

Safety Modules

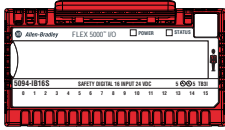

Input Tags

[Table 34](#) describes the 5094-IB16S module input tags.

Table 34 - 5094-IB16S Module Safety Input Tags

Name	Data Type	Definition	Valid Values
RunMode	BOOL	Module's operating state	<ul style="list-style-type: none"> 0 = Idle 1 = Run
ConnectionFaulted	BOOL	Indicates if a connection is running. The module sets this tag to 0 when connected. If the module is not connected, it changes the tag to 1.	<ul style="list-style-type: none"> 0 = Connection running 1 = Connection not running
DiagnosticActive	BOOL	Indicates if any diagnostics are active or if the prognostics threshold is reached.	<ul style="list-style-type: none"> 0 = No diagnostics active 1 = One or more diagnostics are active or the prognostics threshold is reached
DiagnosticSequenceCount	SINT	Increments for each time a distinct diagnostic condition is detected, and when a distinct diagnostic condition transitions from detected to not detected. Set to zero by product reset or power cycle. Wraps from 255 (-1) to 1 skipping zero.	-128 . . . +127 The value of 0 is skipped except during module powerup.
Ptxx.Data	BOOL	Indicates the current safety input value.	<ul style="list-style-type: none"> 0 = Off 1 = On
Ptxx.Fault	BOOL	<ul style="list-style-type: none"> Indicates that channel data is inaccurate and cannot be trusted for use in the application. For more information, see Module Data Quality Reporting on page 47. The channel is set to Not Used. 	<ul style="list-style-type: none"> 0 = Good data 1 = Bad data (faulted) or set to Not Used <ul style="list-style-type: none"> If the tag is set to 1, you must troubleshoot the module to correct the cause of the inaccuracy. IMPORTANT: Once the condition that causes the tag to change to 1 is removed, you must complete the steps described in Safety Input Fault Reset on page 74 to reset this tag to 0. If the tag is 1 because the channel is set to Not Used, no action is required.
Ptxx.Uncertain	BOOL	Indicates that the channel data can be inaccurate but the degree of inaccuracy is not known . For more information, see Module Data Quality Reporting on page 47 .	<ul style="list-style-type: none"> 0 = Good data 1 = Uncertain data <p>This tag is set to 1 when the module has reached a critical operating temperature or is higher the acceptable operating temperature.</p> <p>IMPORTANT: Once the condition that causes the tag to change to 1 is removed, the tag automatically resets to 0.</p>
Ptxx.ShortCircuit	BOOL	Indicates a short circuit.	<ul style="list-style-type: none"> 0 = No short circuit 1 = Short circuit
Ptxx.Status	BOOL	Indicates the status of the channel.	<ul style="list-style-type: none"> 0 = Bad, causing a fault 1 = Good

Test Output Tags

Table 35 - 5094-IB16S Module Test Output Tags

Name	Data Type	Definition	Valid Values
Testxx.Readback	BOOL	Indicates that a 24V DC power source is present at the test output.	<ul style="list-style-type: none"> 0 = 24V DC power is not present 1 = 24V DC power is present
Testxx.Fault	BOOL	<ul style="list-style-type: none"> Indicates that channel data is inaccurate and cannot be trusted for use in the application. For more information, see Module Data Quality Reporting on page 47. The channel is set to Not Used. 	<ul style="list-style-type: none"> 0 = Good data 1 = Bad data (faulted) or set to Not Used <ul style="list-style-type: none"> If the tag is set to 1, you must troubleshoot the module to correct the cause of the inaccuracy. If the tag is 1 because the channel is set to Not Used, no action is required.
Testxx.Uncertain	BOOL	Indicates that the channel data can be inaccurate but the degree of inaccuracy is not known . For more information, see Module Data Quality Reporting on page 47 .	<ul style="list-style-type: none"> 0 = Good data 1 = Uncertain data This tag is set to 1 when the module has reached a critical operating temperature or is higher the acceptable operating temperature. IMPORTANT: Once the condition that causes the tag to change to 1 is removed, the tag automatically resets to 0.
Testxx.ShortCircuit	BOOL	Indicates an output short circuit	<ul style="list-style-type: none"> 0 = No short circuit 1 = Short circuit
Testxx.FieldPowerOff	BOOL	Indicates that a field power loss condition exists on the channel.	<ul style="list-style-type: none"> 0 = No field power off condition 1 = Field power off condition
Testxx.Status	BOOL	Indicates the channel status.	<ul style="list-style-type: none"> 0 = Fault 1 = Good

Output Tags

[Table 36](#) describes the 5094-IB16S module output tags.

Table 36 - 5094-IB16S Module Safety Output Tags

Name	Data Type	Definition	Valid Values
Pt00.ResetFault	BOOL	When 'Latch Fault until reset via output tag' mode is Enabled, the IO channel will hold safety input fault indications until it checks that the fault is removed. If the fault is removed, it will clear only the fault status upon detecting that the ResetFault bit in its channel sees a rising edge.	Rising edge: the fault status is released if the fault has been removed.

5094-OB16 Module Tags

This section describes the tags that are associated with the 5094-OB16 module.

Standard Modules

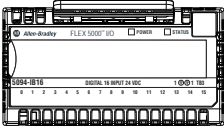

Configuration Tags

[Table 37](#) describes the 5094-OB16 module configuration tags.

Table 37 - 5094-OB16 Module Configuration Tags

Name	Data Type	Definition	Valid Values
Ptxx.FaultMode	BOOL	Selects the behavior the output point takes if a communication fault occurs. FaultValue defines the value to go to when set to user-defined value.	<ul style="list-style-type: none"> 0 = Go to a user-defined value 1 = Hold last state
Ptxx.FaultValue	BOOL	Defines the value that the discrete output should assume if a communication fault occurs when FaultMode = 0.	<ul style="list-style-type: none"> 0 = Off 1 = On
Ptxx.ProgMode	BOOL	Selects the behavior the output point should take when transitioned into Program mode. ProgValue defines the value to go to when set to user-defined value.	<ul style="list-style-type: none"> 0 = Go to a user-defined value 1 = Hold last state
Ptxx.ProgValue	BOOL	Defines the value that the output should take when the connection transitions to Program mode if the ProgMode bit is set to "User-Defined Value".	<ul style="list-style-type: none"> 0 = The output state is Off during Program mode. 1 = The output state is On during Program mode.
Ptxx.FaultFinalState	BOOL	If FaultValueStateDuration is nonzero determines the final Output state after the configured FaultValueStateDuration time out occurs.	<ul style="list-style-type: none"> 0 = The output state is Off after the FaultValueStateDuration time expires. 1 = The output state is On after the FaultValueStateDuration time expires.
Ptxx.ProgramToFaultEn	BOOL	Determines if an output should transition to the Fault Mode if the connection faults while in Program Mode.	<ul style="list-style-type: none"> 0 = Stay in Program Mode 1 = Go to Fault mode
Ptxx.NoLoadEn	BOOL	Enables no load detection for output points.	<ul style="list-style-type: none"> 0 = Disable 1 = Enable
Ptxx.FaultValueStateDuration	SINT	This value determines the length of time the Fault Mode state is held before the FaultFinalState being applied.	<ul style="list-style-type: none"> 0 = Hold forever (default). 1, 2, 5, or 10 seconds

Input Tags

Table 38 describes the 5094-OB16 module input tags.

Table 38 - 5094-OB16 Module Input Tags

Name	Data Type	Definition	Valid Values
RunMode	BOOL	The point's operating state	<ul style="list-style-type: none"> 0 = Idle 1 = Run Mode
ConnectionFaulted	BOOL	Indicates if a connection is running. The module sets this tag to 0 when connected. If the module is not connected, it changes the tag to 1.	<ul style="list-style-type: none"> 0 = Connection running 1 = Connection not running
DiagnosticActive	BOOL	Indicates if any diagnostics are active or if the prognostics threshold is reached.	<ul style="list-style-type: none"> 0 = No diagnostics active 1 = One or more diagnostics are active or the prognostics threshold is reached
Uncertain	BOOL	Indicates if the module is operating outside its designed operating range or if data is under manual or override control.	<ul style="list-style-type: none"> 0 = Good 1 = Uncertain
DiagnosticSequenceCount	SINT	Increments for each time a distinct diagnostic condition is detected, and when a distinct diagnostic condition transitions from detected to not detected. Set to zero by product reset or power cycle. Wraps from 255 (-1) to 1, skipping zero.	-128...+127 The value of 0 is skipped except during module powerup.
CIPSyncValid	BOOL	Indicates whether the module is synced with a 1588 master.	<ul style="list-style-type: none"> 0 = CIP Sync is not available 1 = CIP Sync is available
CIPSyncTimeout	BOOL	Indicates that the module was once synced with a 1588 master, but is not now due to a timeout.	<ul style="list-style-type: none"> 0 = A valid time master has not timed out 1 = A valid time master was detected on the backplane, but the time master has timed out. The module is using its local clock and can be drifting away from the last known master time.
Ptxx.Data	BOOL	Indicates the current digital input value.	<ul style="list-style-type: none"> 0 = Off 1 = On
Ptxx.Fault	BOOL	Indicates that point data is inaccurate and cannot be trusted for use in the application. For more information, see Module Data Quality Reporting on page 47 .	<ul style="list-style-type: none"> 0 = Good 1 = Bad, causing fault <p>The typical causes of uncertain data are the following:</p> <ul style="list-style-type: none"> Field Power Loss condition No Load condition Short Circuit condition <p>If the tag is set to 1, you must troubleshoot the module to correct the cause of the inaccuracy. IMPORTANT: Once the condition that causes the tag to change to 1 is removed, the tag automatically resets to 0.</p>
Ptxx.Uncertain	BOOL	Indicates that the point data can be inaccurate but the degree of inaccuracy is not known. For more information, see Module Data Quality Reporting on page 47 .	<ul style="list-style-type: none"> 0 = Good data 1 = Uncertain data <p>If the tag is set to 1, you must troubleshoot the module to correct the cause of the inaccuracy. IMPORTANT: Once the condition that causes the tag to change to 1 is removed, the tag automatically resets to 0.</p>
Ptxx.NoLoad	BOOL	Indicates that the signal wire has been disconnected from one of its terminals or the RTB has been removed. Used with Output points.	<ul style="list-style-type: none"> 0 = No fault 1 = Fault
Ptxx.ShortCircuit	BOOL	Indicates an output short circuit or overcurrent.	<ul style="list-style-type: none"> 0 = No short circuit 1 = Short circuit or overcurrent

Output Tags

[Table 39](#) describes the 5094-OB16 module output tags.

Table 39 - 5094-OB16 Module Output Tags

Name	Data Type	Definition	Valid Values
TimeBase	LINT	Indicates the TimeBase for all schedule times in a scheduled output consumed assembly or point. The TimeBase + The Schedule[n].TimeOffset determines the time for the schedule. Base/Offset scheme that is used to fit enough schedules into the assembly.	Any positive value.
Ptxx.Data	BOOL	Current digital input value.	<ul style="list-style-type: none"> • 0 = Off • 1 = On
Ptxx.ScheduleEn	BOOL	Specifies the use of normal output data or scheduled data.	<ul style="list-style-type: none"> • 0 = Normal output data • 1 = Scheduled data
Schedulex	SINT	Indicates which schedule to load from 32 available schedules.	<ul style="list-style-type: none"> • 1...32 = Valid schedule • 0, 129...255 = No schedule
Schedulex.ID	SINT	There are 32 schedules available (for Neo R1 products). Indicates which schedule to load.	<ul style="list-style-type: none"> • 1...32 = Valid schedule • 0 or 129...255 = No schedule
Schedulex.SequenceNumber	SINT	Indicates that the schedule information is valid and that this schedule should be processed.	All values.
Schedulex.OutputPointSelect	SINT	Selects the output point that this schedule applies to. 0xFF means no output point selected.	0...15
Schedulex.Data	BOOL	Output data to be applied at time that is specified in schedule.	0 or 1
Schedulex.TimeOffset	DINT	Offset from schedule base time. Used for scheduled output consumed tags. Base/Offset scheme that is used to fit enough schedules in the assembly.	All values.

5094-OB16S Module Tags

This section describes the tags that are associated with the 5094-OB16S module.

Safety Modules

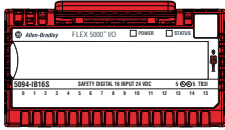

Input Tags

[Table 40](#) describes the 5094-OB16S module input tags.

Table 40 - 5094-OB16S Module Safety Input Tags

Name	Data Type	Definition	Valid Values
RunMode	BOOL	The point's operating state	<ul style="list-style-type: none"> 0 = Idle 1 = Run Mode
ConnectionFaulted	BOOL	Indicates if a connection is running. The module sets this tag to 0 when connected. If the module is not connected, it changes the tag to 1.	<ul style="list-style-type: none"> 0 = Connection running 1 = Connection not running
DiagnosticActive	BOOL	Indicates if any diagnostics are active or if the prognostics threshold is reached.	<ul style="list-style-type: none"> 0 = No diagnostics active 1 = One or more diagnostics are active or the prognostics threshold is reached
DiagnosticSequenceCount	SINT	Increments for each time a distinct diagnostic condition is detected, and when a distinct diagnostic condition transitions from detected to not detected. Set to zero by product reset or power cycle. Wraps from 255 (-1) to 1, skipping zero.	-128...+127 The value of 0 is skipped except during module powerup.
Ptxx.Readback	BOOL	Indicates the current digital output value.	<ul style="list-style-type: none"> 0 = Off 1 = On
Ptxx.Fault	BOOL	<ul style="list-style-type: none"> Indicates that point data is inaccurate and cannot be trusted for use in the application. For more information, see Module Data Quality Reporting on page 47. The channel is set to Not Used. 	<ul style="list-style-type: none"> 0 = Good data 1 = Bad data (faulted) or set to Not Used <p>If the tag is set to 1, you must troubleshoot the module to correct the cause of the inaccuracy.</p> <p>IMPORTANT: Once the condition that causes the tag to change to 1 is removed, you must complete the steps described in Safety Output Fault Reset on page 83 to reset this tag to 0.</p> <p>If the tag is 1 because the channel is set to Not Used, no action is required.</p>
Ptxx.Uncertain	BOOL	<p>Indicates that the point data can be inaccurate but the degree of inaccuracy is not known. For more information, see Module Data Quality Reporting on page 47.</p> <p>Indicates OverTemperature and CriticalTemperature situation in 5094-OB16S module.</p>	<ul style="list-style-type: none"> 0 = Good data 1 = Uncertain data <p>If the tag is set to 1, you must troubleshoot the module to correct the cause of the inaccuracy.</p> <p>IMPORTANT: Once the condition that causes the tag to change to 1 is removed, the tag automatically resets to 0.</p>
Ptxx.FieldPowerOff	BOOL	Indicates that a field power loss condition exists on the channel	<ul style="list-style-type: none"> 0 = No field power off condition 1 = Field power off condition
Ptxx.ShortCircuit	BOOL	Indicates an output short circuit or overcurrent.	<ul style="list-style-type: none"> 0 = No short circuit 1 = Short circuit or overcurrent
Ptxx.Status	BOOL	Indicates the status of the channel.	<ul style="list-style-type: none"> 0 = Bad, causing a fault 1 = Good

Output Tags

[Table 41](#) describes the 5094-OB16S module output tags.

Table 41 - 5094-OB16S Module Safety Output Tags

Name	Data Type	Definition	Valid Values
Ptxx.Data	BOOL	Indicates the current digital output value.	<ul style="list-style-type: none"> • 0 = Off • 1 = On
Ptxx.ResetFault	BOOL	When 'Latch Fault until reset via output tag' mode is Enabled, the I/O channel will hold safety output fault indications until it checks that the fault is removed. If the fault is removed, it will clear only the fault status upon detecting that the ResetFault bit in its channel sees a rising edge.	Rising edge: the fault status is released if the fault has been removed.

5094-OW4IS Module Tags

This section describes the tags that are associated with the 5094-OW4IS module.

Safety Modules

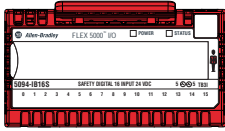

Input Tags

Table 42 describes the 5094-OW4IS module input tags.

Table 42 - 5094-OW4IS Module Safety Input Tags

Name	Data Type	Definition	Valid Values
RunMode	BIT	The point's operating state	<ul style="list-style-type: none"> 0 = Idle 1 = Run Mode
ConnectionFaulted	BIT	Indicates if a connection is running. The module sets this tag to 0 when connected. If the module is not connected, it changes the tag to 1.	<ul style="list-style-type: none"> 0 = Connection running 1 = Connection not running
DiagnosticActive	BIT	Indicates if any diagnostics are active or if the prognostics threshold is reached.	<ul style="list-style-type: none"> 0 = No diagnostics active 1 = One or more diagnostics are active or the prognostics threshold is reached
DiagnosticSequenceCount	SINT	Increments for each time a distinct diagnostic condition is detected, and when a distinct diagnostic condition transitions from detected to not detected. Set to zero by product reset or power cycle. Wraps from 255 (-1) to 1, skipping zero.	-128...+127 The value of 0 is skipped except during module powerup.
Ptxx.Readback	BOOL	Indicates the current digital output value.	<ul style="list-style-type: none"> 0 = Off 1 = On
Ptxx.Fault	BOOL	<ul style="list-style-type: none"> Indicates that point data is inaccurate and cannot be trusted for use in the application. For more information, see Module Data Quality Reporting on page 47. The channel is set to Not Used. 	<ul style="list-style-type: none"> 0 = Good data 1 = Bad data (faulted) or set to Not Used <p>If the tag is set to 1, you must troubleshoot the module to correct the cause of the inaccuracy.</p> <p>IMPORTANT: Once the condition that causes the tag to change to 1 is removed, you must complete the steps described in Safety Relay Output Fault Reset on page 85 to reset this tag to 0.</p> <p>If the tag is 1 because the channel is set to Not Used, no action is required.</p>
Ptxx.Uncertain	BOOL	<ul style="list-style-type: none"> Indicates that the point data can be inaccurate but the degree of inaccuracy is not known. For more information, see Module Data Quality Reporting on page 47. Indicates OverTemperature and CriticalTemperature situation in 5094-OW4IS module. Indicates Shock & Vibration reaching operation limits. 	<ul style="list-style-type: none"> 0 = Good data 1 = Uncertain data <p>If the tag is set to 1, you must troubleshoot the module to correct the cause of the inaccuracy.</p> <p>IMPORTANT: Once the condition that causes the tag to change to 1 is removed, the tag automatically resets to 0.</p>
Ptxx.FieldPowerOff	BOOL	Indicates that a field power loss condition exists on the channel.	<ul style="list-style-type: none"> 0 = No field power off condition 1 = Field power off condition
Ptxx.Status	BOOL	Indicates the status of the channel.	<ul style="list-style-type: none"> 0 = Bad, causing a fault 1 = Good

Output Tags

[Table 43](#) describes the 5094-OW4IS modules output tags.

Table 43 - 5094-OW4IS Module Safety Output Tags

Name	Data Type	Definition	Valid Values
Ptxx.Data	BOOL	Indicates the current digital output value.	<ul style="list-style-type: none"> 0 = Off 1 = On
Ptxx.ResetFault	BOOL	When 'Latch Fault until reset via output tag' mode is Enabled, the I/O channel will hold safety output fault indications until it checks that the fault is removed. If the fault is removed, it will clear only the fault status upon detecting that the ResetFault bit in its channel sees a rising edge.	Rising edge: the fault status is released if the fault has been removed.

5094-OW8I Module Tags

This section describes the tags that are associated with the 5094-OW8I module.

Standard Modules

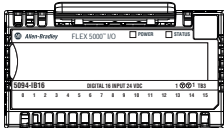

Configuration Tags

[Table 44](#) describes the 5094-OW8I module configuration tags.

Table 44 - 5094-OW8I Module Configuration Tags

Name	Data Type	Definition	Valid Values
Ptxx.FaultMode	BOOL	Selects the behavior the output point takes if a communication fault occurs. FaultValue defines the value to go to when set to user-defined value.	<ul style="list-style-type: none"> 0 = Go to a user-defined value 1 = Hold last state
Ptxx.FaultValue	BOOL	Defines the value that the discrete output should assume if a communication fault occurs when FaultMode = 0.	<ul style="list-style-type: none"> 0 = Off 1 = On
Ptxx.ProgMode	BOOL	Selects the behavior the output point should take when transitioned into Program mode. ProgValue defines the value to go to when set to user-defined value.	<ul style="list-style-type: none"> 0 = Go to a user-defined value 1 = Hold last state
Ptxx.ProgValue	BOOL	Defines the value that the output should take when the connection transitions to Program mode if the ProgMode bit is set to "User-Defined Value".	<ul style="list-style-type: none"> 0 = The output state is Off during Program mode. 1 = The output state is On during Program mode.
Ptxx.FaultFinalState	BOOL	If FaultValueStateDuration is nonzero determines the final Output state after the configured FaultValueStateDuration time out occurs.	<ul style="list-style-type: none"> 0 = The output state is Off after the FaultValueStateDuration time expires. 1 = The output state is On after the FaultValueStateDuration time expires.
Ptxx.ProgramToFaultEn	BOOL	Determines if an output should transition to the Fault Mode if the connection faults while in Program Mode.	<ul style="list-style-type: none"> 0 = Stay in Program Mode 1 = Go to Fault mode
Ptxx.FaultValueStateDuration	SINT	This value determines the length of time the Fault Mode state is held before the FaultFinalState being applied.	<ul style="list-style-type: none"> 0 = Hold forever (default). 1, 2, 5, or 10 seconds

Input Tags

Table 45 describes the 5094-OW8I module input tags.

Table 45 - 5094-OW8I Module Input Tags

Name	Data Type	Definition	Valid Values
RunMode	BOOL	The point's operating state	<ul style="list-style-type: none"> 0 = Idle 1 = Run Mode
ConnectionFaulted	BOOL	Indicates if a connection is running. The module sets this tag to 0 when connected. If the module is not connected, it changes the tag to 1.	<ul style="list-style-type: none"> 0 = Connection running 1 = Connection not running
DiagnosticActive	BOOL	Indicates if any diagnostics are active or if the prognostics threshold is reached.	<ul style="list-style-type: none"> 0 = No diagnostics active 1 = One or more diagnostics are active or the prognostics threshold is reached
DiagnosticSequenceCount	SINT	Increments for each time a distinct diagnostic condition is detected, and when a distinct diagnostic condition transitions from detected to not detected. Set to zero by product reset or power cycle. Wraps from 255 (-1) to 1, skipping zero.	-128...+127 The value of 0 is skipped except during module powerup.
Ptxx.Data	BOOL	Indicates the current digital input value.	<ul style="list-style-type: none"> 0 = Off 1 = On
Ptxx.Fault	BOOL	Indicates that point data is inaccurate and cannot be trusted for use in the application. For more information, see Module Data Quality Reporting on page 47 .	<ul style="list-style-type: none"> 0 = Good 1 = Bad, causing fault <p>The typical causes of uncertain data are the following:</p> <ul style="list-style-type: none"> Field Power Loss condition <p>If the tag is set to 1, you must troubleshoot the module to correct the cause of the inaccuracy.</p> <p>IMPORTANT: Once the condition that causes the tag to change to 1 is removed, the tag automatically resets to 0.</p>
Ptxx.Uncertain	BOOL	Indicates that the point data can be inaccurate but the degree of inaccuracy is not known. For more information, see Module Data Quality Reporting on page 47 .	<ul style="list-style-type: none"> 0 = Good data 1 = Uncertain data <p>If the tag is set to 1, you must troubleshoot the module to correct the cause of the inaccuracy.</p> <p>IMPORTANT: Once the condition that causes the tag to change to 1 is removed, the tag automatically resets to 0.</p>

Output Tags

Table 46 describes the 5094-OW8I module outputs tags.

Table 46 - Relay Output High Current Module Output Tags

Name	Data Type	Definition	Valid Values
Ptxx.Data	BIT	Indicates the current digital input value.	<ul style="list-style-type: none"> 0 = Off 1 = On

Application/Wiring Examples for Safety I/O Modules

Safety Modules

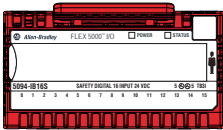

Topic	Page
5094-IB16S and 5094-IB16SXT Module Wiring Diagrams	160
5094-OB16S and 5094-OB16SXT Module Wiring Diagrams	165
5094-OW4IS and 5094-OW4ISXT Relay Module Wiring Diagrams	167

This appendix provides example wiring diagrams for the FLEX 5000™ I/O safety modules that can be used in functional safety applications.

The wiring configuration affects the safety application level to which a FLEX 5000 I/O safety module is suitable.

IMPORTANT Conformity to requirements of the safety category and safety integrity level must be determined **for the entire system**. You need to consider fault exclusion specified in each of the wiring configurations.

5094-IB16S and 5094-IB16SXT Module Wiring Diagrams

The following wiring diagrams show the input modules in Safety Mode and Safety Pulse Mode.

Test Output Association with Safety Input:

- TO_0: SI_0, SI_8
- TO_1: SI_1, SI_9
- TO_2: SI_2, SI_10
- TO_3: SI_3, SI_11
- TO_4: SI_4, SI_12
- TO_5: SI_5, SI_13
- TO_6: SI_6, SI_14
- TO_7: SI_7, SI_15

Note: In Safety Pulse mode, if external wiring short of 2 Safety inputs from the same Test Output point, the short circuit is not detectable. Hence, in Dual Channel mode, use 2 Safety Inputs from different Test Output points.

Figure 29 - 5094-IB16S Module - SIL 3, PLc, Cat. 2 in Safety Pulse Mode or Safety Mode

SIL level and Category: SIL 3, PLc, Cat. 2
Fault Exclusion: None
 Other: External connected device must be SIL 3 rated.
 Point Mode: Safety Pulse Mode, Safety Mode

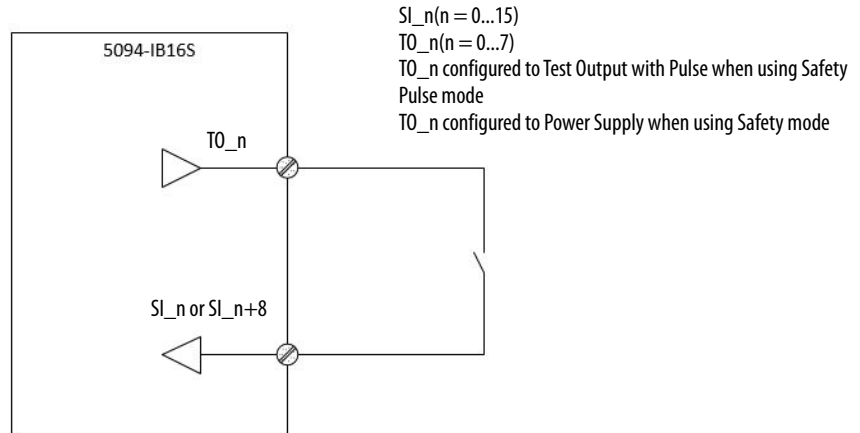

Figure 30 - 5094-IB16S Module - SIL 3, PLc, Cat. 2 in Safety Mode

SIL level and Category: SIL 3, PLc, Cat. 2
Fault Exclusion: None
 Other: External connected device must be SIL 3 rated.
 Point Mode: Safety Mode

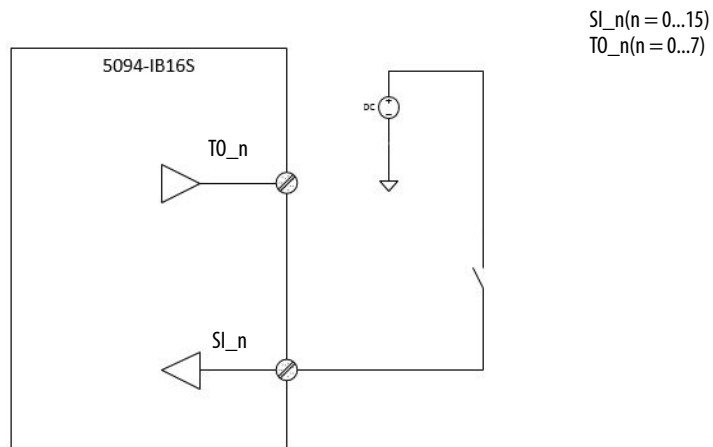

Figure 31 - 5094-IB16S Module - SIL 3, PLe, Cat. 4 in Safety Pulse Mode or Safety Mode

SIL level and Category: SIL 3, PLe, Cat. 4
Fault Exclusion: External Wiring fault
 Other: Use SIL 3/CAT 4/PLe qualified sensor.
 Point Mode: Safety Pulse mode, Safety mode

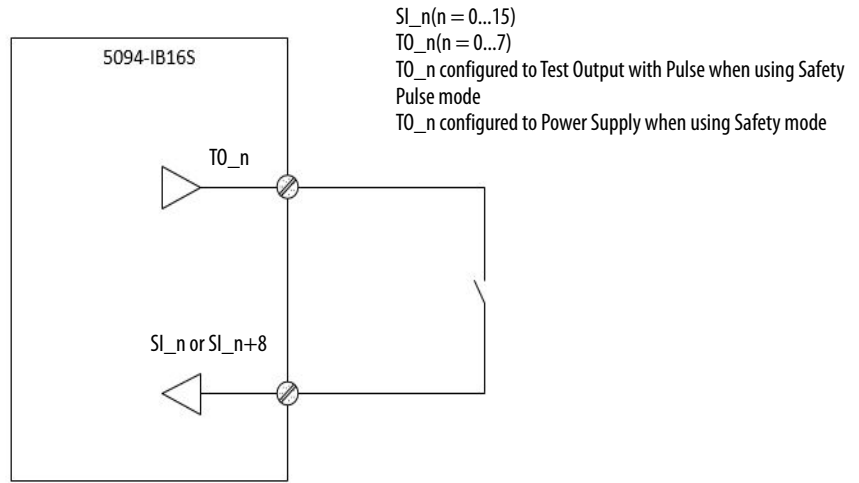

Figure 32 - 5094-IB16S Module - SIL 3, PLe, Cat. 4 in Safety Mode

SIL level and Category: SIL 3, PLe, Cat. 4
Fault Exclusion: External Wiring fault
 Other: Use SIL 3/CAT 4/PLe qualified sensor.
 Point Mode: Safety mode

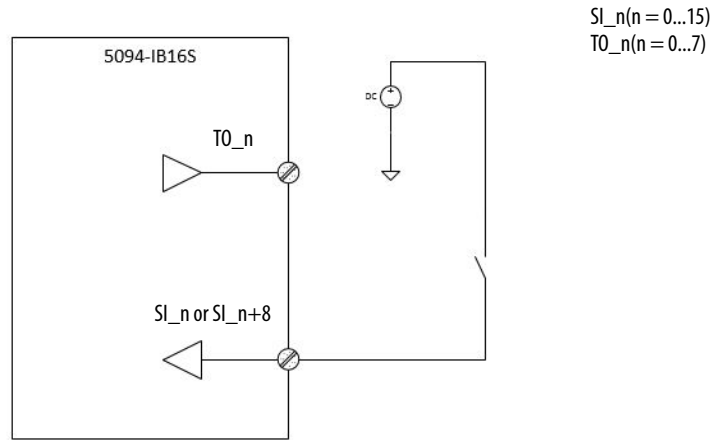
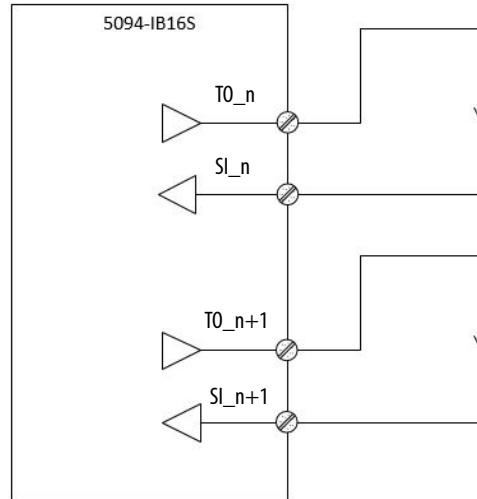

Figure 33 - 5094-IB16S Module - SIL 3, PLe, Cat. 4 in Safety Pulse Mode

SIL level and Category: SIL 3, PLe, Cat. 4
Fault Exclusion: None
 Point Mode: Safety Pulse Mode



SI_n(n = 0...15)
 TO_n(n = 0...7)

The second SI channel can be any channel other than SI_n+8.

Figure 34 - 5094-IB16S Module - SIL 3, PLe, Cat. 4 in Safety Mode

SIL level and Category: SIL 3, PLe, Cat. 4
Fault Exclusion: External Wiring fault
 Point Mode: Safety Mode

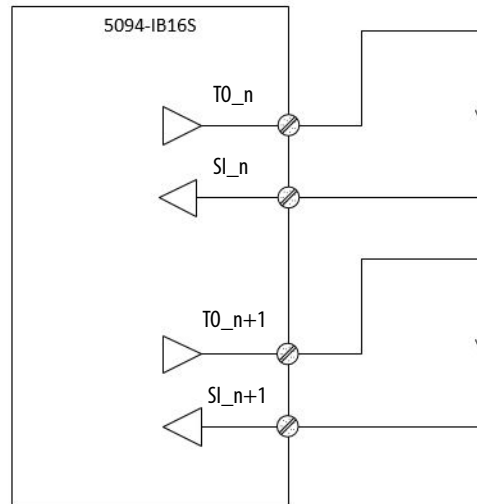

SI_n(n = 0...15)
 TO_n(n = 0...7)

The second SI channel can be any channel other than SI_n+8.

Figure 35 - 5094-IB16S Module - SIL 3, PLe, Cat. 4 in Safety Pulse Mode

SIL level and Category: SIL 3, PLe, Cat. 4
Fault Exclusion: None
 Point Mode: Safety Pulse Mode

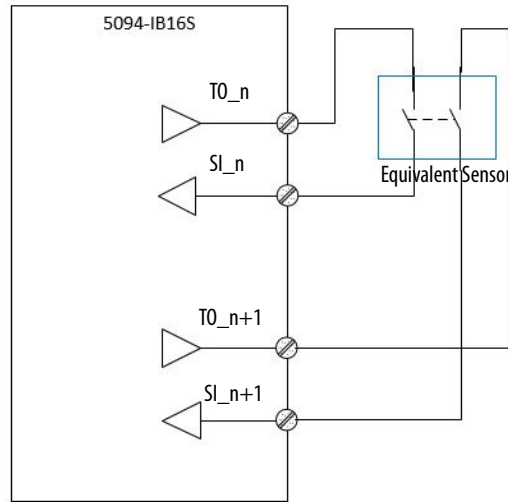

SI_n(n = 0...15)
 TO_n(n = 0...7)

The second SI channel can be any channel other than SI_n+8.

Figure 36 - 5094-IB16S Module - SIL 3, PLe, Cat. 4 in Safety Mode

SIL level and Category: SIL 3, PLe, Cat. 4
Fault Exclusion: External Wiring fault
 Point Mode: Safety Mode

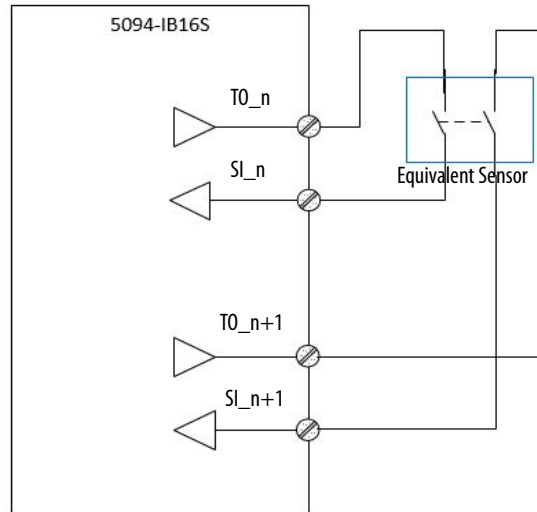

SI_n(n = 0...15)
 TO_n(n = 0...7)

The second SI channel can be any channel other than SI_n+8.

Figure 37 - 5094-IB16S Module - SIL 3, PLe, Cat. 4 in Safety Pulse Mode

SIL level and Category: SIL 3, PLe, Cat. 4
Fault Exclusion: None
 Point Mode: Safety Pulse Mode

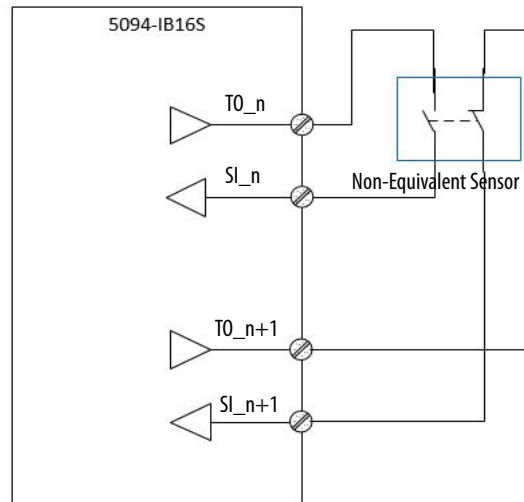

SI_n(n = 0...15)
 TO_n(n = 0...7)

The second SI channel can be any channel other than SI_n+8.

Figure 38 - 5094-IB16S Module - SIL 3, PLe, Cat. 4 in Safety Mode

SIL level and Category: SIL 3, PLe, Cat. 4
Fault Exclusion: External Wiring fault
 Point Mode: Safety Mode

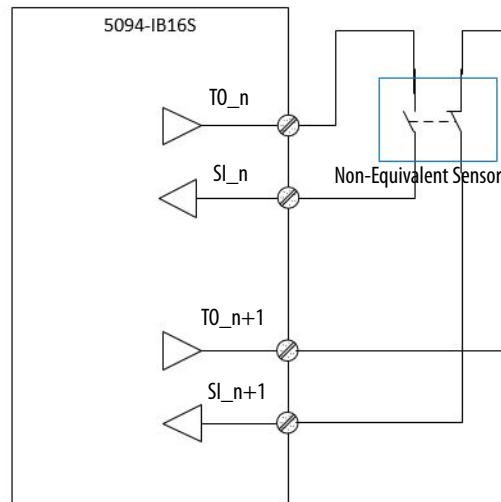

SI_n(n = 0...15)
 TO_n(n = 0...7)

The second SI channel can be any channel other than SI_n+8.

5094-OB16S and 5094-OB16SXT Module Wiring Diagrams

The following wiring diagrams show the output modules in Safety Mode and Safety Pulse Mode.

IMPORTANT The Safety level shown in the diagrams is applicable to the module itself. Connected devices must have their own status monitoring to achieve application safety level.

SIL level and Category: SIL 3, PLc, Cat. 2
Fault Exclusion: None
 Other: External connected device must be SIL 3 rated.
 Point Mode: Safety Pulse Mode, Safety Mode

Figure 39 - 5094-OB16S Module - SIL 3, PLc, Cat. 2 in Safety Mode or Safety Pulse Mode

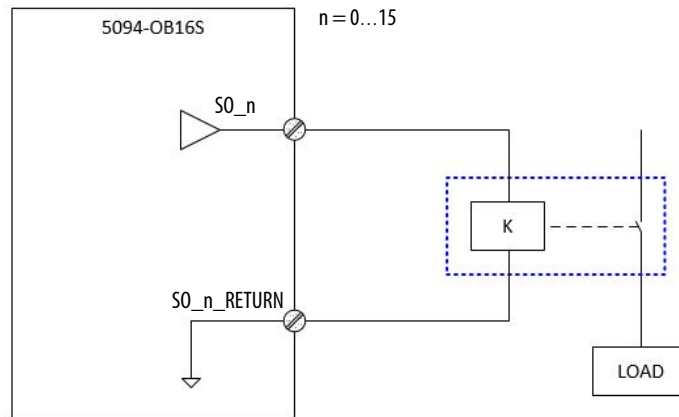

Figure 40 - 5094-OB16S Module - SIL 3, PLe, Cat. 4 in Safety Pulse Mode

SIL level and Category: SIL 3, PLe, Cat. 4
Fault Exclusion: None
 Point Mode: Safety Pulse Mode

$n = 0 \dots 15$
 The channel pairs that support Dual mode are:
 Channel 0, 1 pair
 Channel 2, 3 pair
 Channel 4, 5 pair
 Channel 6, 7 pair
 Channel 8, 9 pair
 Channel 10, 11 pair
 Channel 12, 13 pair
 Channel 14, 15 pair

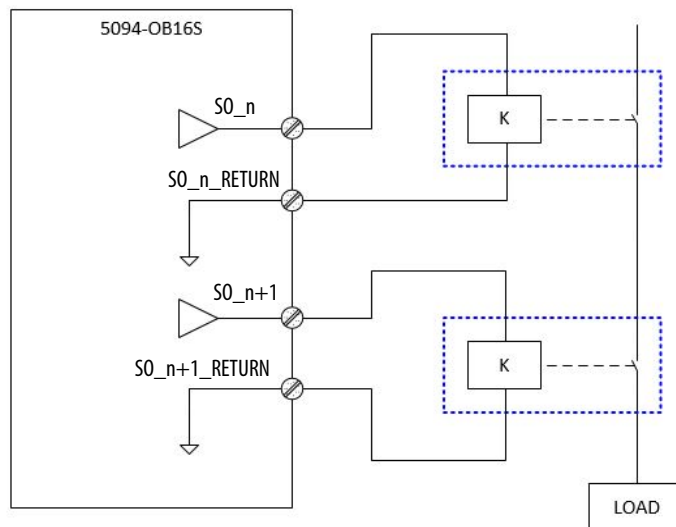

Figure 41 - 5094-OB16S Module - SIL 3, PLe, Cat. 4 in Safety Mode

SIL level and Category: SIL 3, PLe, Cat. 4
Fault Exclusion: External Wiring fault
 Point Mode: Safety Mode

$n = 0 \dots 15$
 The channel pairs that support
 Dual mode are:
 Channel 0, 1 pair
 Channel 2, 3 pair
 Channel 4, 5 pair
 Channel 6, 7 pair
 Channel 8, 9 pair
 Channel 10, 11 pair
 Channel 12, 13 pair
 Channel 14, 15 pair

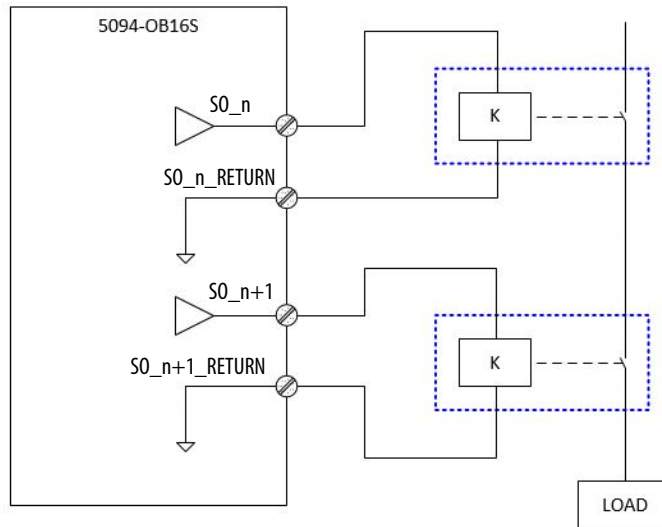
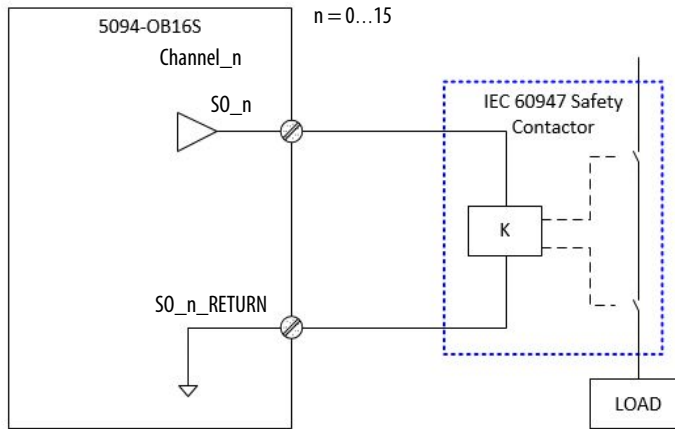

Figure 42 - 5094-OB16S Module - SIL 3, PLe, Cat. 4 in Safety Pulse Mode or Safety Mode

SIL level and Category: SIL 3, PLe, Cat. 4
Fault Exclusion: External Wiring fault
 Other: Use IEC 60947 Safety Contactor.
 Point Mode: Safety Pulse mode, Safety mode



5094-0W4IS and 5094-0W4ISXT Relay Module Wiring Diagrams

The following wiring diagrams show the relay output modules.

IMPORTANT The Safety level shown in below diagram is applicable to module itself.
Connected device shall have their own status monitoring to achieve application safety level.



ATTENTION: When you are using the relay to drive DC/AC inductive load, you must connect a snubber across the load. Failure to connect a snubber across the load (relay contacts) can result in generation of electromagnetic noise that could disrupt nearby electrical equipment, including your 5094 FLEX I/O chassis. See the Industrial Automation Wiring and Grounding Guidelines, publication [1770-4.1](#)

Figure 43 - 5094-0W4IS Module - SIL3, PLe, CAT4

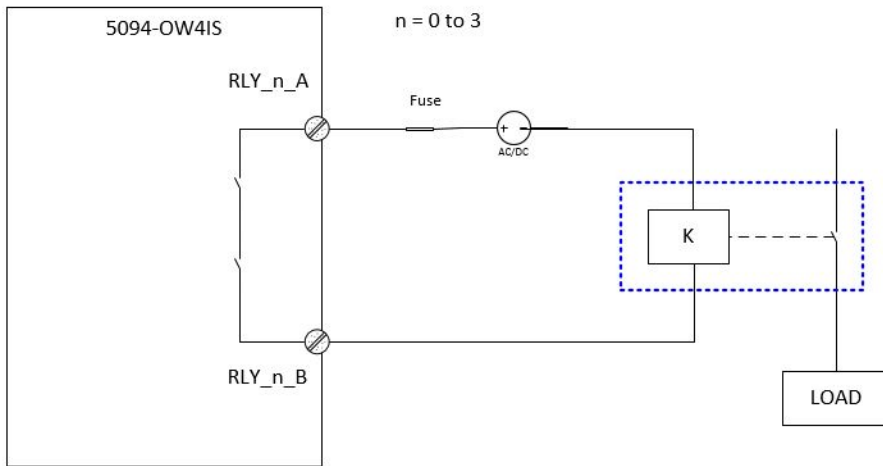

SIL level and Category:

SIL3, PLe, CAT4
(Signal state change at least once a month)

SIL2, PLd, CAT3
(Signal state change at least once a year)

Fault Exclusion:

External Wiring fault

Other:

Qualified actuator must be used in the application
Fuse with proper rating should be connected to prevent relay contacts from overload and short circuit.

Figure 44 - 5094-OW4IS Module - SIL3, PLe, CAT4

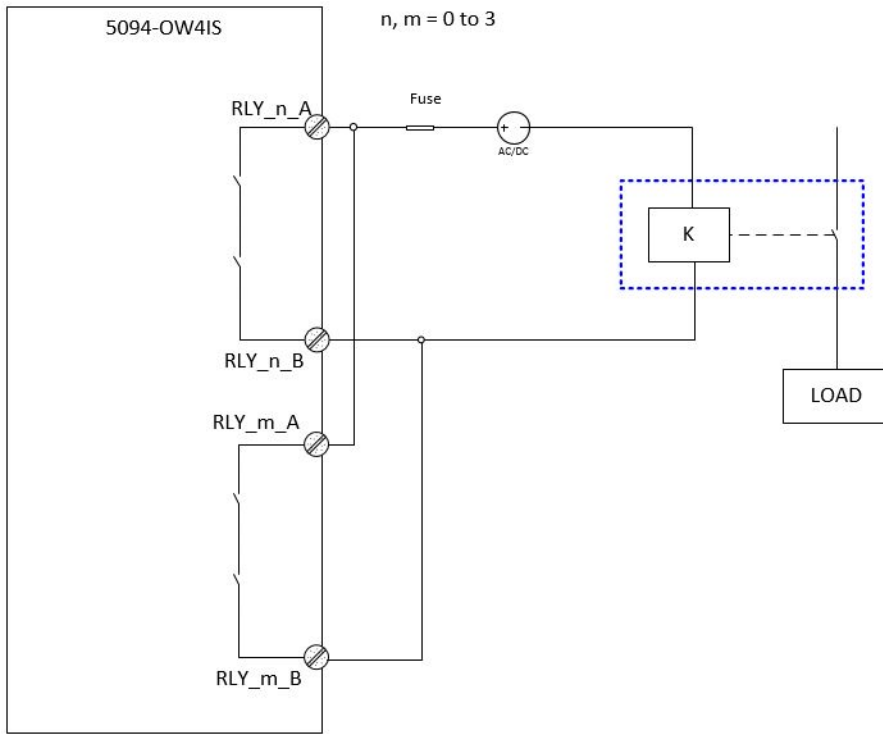

SIL level and Category:

SIL3, PLe, CAT4
 (Ladder logical alternative toggle each channel at least once a month)

Fault Exclusion:

External Wiring fault

Other:

Qualified actuator must be used in the application

Fuse with proper rating should be connected to prevent relay contacts from overload and short circuit.

Safety Data for I/O Modules

Safety Modules

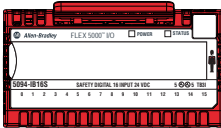

This appendix lists calculated values for probability of a dangerous failure on demand (PFD), average frequency of a dangerous failure per hour (PFH), and mean time to failure (MTTF). PFD and PFH calculations comply with IEC61508, edition 2, 2010.

Calculated values of PFD and PFH appear in [Table 47 on page 170](#). PFD and PFH must be calculated for the devices within the system to comply with the SIL level that is required for application.

You must be responsible for following the requirements of ISO 13849-1:2015, to assess Performance Levels in their safety system.

You must functionally test every I/O module by individually toggling each input point and also verify that the controller detects it within the safety reaction time (SRT). Additionally, you must individually toggle each output point by the controller and user-verify that the output point changes state.

For more information, refer to the FLEX 5000™ safety controller manuals listed in [Additional Resources on page 12](#).

FLEX 5000 I/O Safety Input Module Safety Data

Table 47 lists the safety data for the 5094-IB16S and 5094-IB16SXT modules.

Table 47 - 5094-IB16S and 5094-IB16SXT Digital Safety Parameter Data

Attribute	Point Operation Type	
	Single Channel	Dual Channel (at controller instruction)
Total Failure Rate (λ (safety related))	1.246E-06	1.397E-06
Safe Failure Fraction (SFF)	99.969%	99.967%
Safe Failure Rate (λ_S)	7.97E-07	8.63E-07
Diagnostic Coverage (DC)	99.867%	99.913%
Safe Detected Failure Rate (λ_{SD})	7.96E-07	8.62E-07
Safe Undetected Failure Rate (λ_{SU})	1.06E-09	7.53E-10
Dangerous Failure Rate (λ_D)	4.4950E-07	5.3402E-07
Dangerous Detected Failure Rate (λ_{DD})	4.4890E-07	5.3356E-07
Dangerous Undetected Failure Rate (λ_{DU})	3.81E-10	4.6619E-10
Diagnostic Test Interval (hours)	4	4
Hardware Fault Tolerance (HFT)	0	1
Spurious Trip Rate (STR)	5.40 E-06	—
Mean Time to Failure, Spurious (MTTF-spurious), (hours)	185068	—
PFH (1/hours)	3.81E-10	4.6619E-10
PFDAVEr at Mission Time of 20 years	3.34E-05	4.08E-05
Safety Reaction Time (SRT), (millisecond)	6	6

FLEX 5000 I/O Safety Output Module Safety Data

Table 48 lists the safety data for the 5094-OB16S and 5094-OB16SXT modules.

Table 48 - 5094-OB16S and 5094-OB16SXT Digital Safety Parameter Data

Attribute	Point Operation Type	
	Single Channel	Dual Channel
Total Failure Rate (λ (safety related))	2.0565E-06	2.5524E-06
Safe Failure Fraction (SFF)	99.977%	99.983%
Safe Failure Rate (λ_S)	1.3238E-06	1.5666E-06
Safe Detected Failure Rate (λ_{SD})	1.32E-06	1.57E-06
Safe Undetected Failure Rate (λ_{SU})	8.40E-10	6.86E-10
Diagnostic Coverage (DC)	99.937%	99.956%
Dangerous Failure Rate (λ_D)	7.3278E-07	9.8585E-07
Dangerous Detected Failure Rate (λ_{DD})	7.3232E-07	9.8541E-07
Dangerous Undetected Failure Rate (λ_{DU})	4.6523E-10	4.3173E-10
Diagnostic Test Interval (hours)	4	4
Hardware Fault Tolerance (HFT)	0	1
Spurious Trip Rate (STR)	5.68E-06	—
Mean Time to Failure, Spurious (MTTF-spurious), (hours)	176037	—
PFH (1/hours)	4.6523E-10	4.3173E-10
PFDAVE at Mission Time of 20 years	4.0754E-05	3.7819E-05
Safety Reaction Time (SRT), (millisecond)	4.5	4.5

FLEX 5000 I/O Safety Relay Output Module Safety Data

Table 49 lists the safety data for the 5094-OW4IS and 5094-OW4ISXT modules.

Table 49 - 5094-OW4IS and 5094-OW4ISXT Digital Safety Parameter Data

Attribute	Point Operation Type	
	Single Channel	Dual Channel
Total Failure Rate (λ (safety related))	2.2470E-06	2.8740E-06
Safe Failure Fraction (SFF)	99.978%	99.984%
Safe Failure Rate (λ_S)	1.7129E-06	2.2634E-06
Diagnostic Coverage (DC)	99.909%	99.924%
Safe Detected Failure Rate (λ_{SD})	1.71E-06	2.26E-06
Safe Undetected Failure Rate (λ_{SU})	1.56E-09	1.73E-09
Dangerous Failure Rate (λ_D)	5.3388E-07	6.1058E-07
Dangerous Detected Failure Rate (λ_{DD})	5.3340E-07	6.1011E-07
Dangerous Undetected Failure Rate (λ_{DU})	4.8580E-10	4.6557E-10
Diagnostic Test Interval (hours)	4	4
Hardware Fault Tolerance (HFT)	0	1
Spurious Trip Rate (STR)	5.25E-06	—
Mean Time to Failure, Spurious (MTTF-spurious), (hours)	190638	—
PFH (1/hours)	4.8580E-10	4.6557E-10
PFDAVEr at Mission Time of 20 years	4.2556E-05	4.0784E-05
Safety Reaction Time (SRT), (millisecond)	20	20

Numerics

5094-IB16 18
5094-IB16S 18
5094-IB16SXT 18
5094-IB16XT 18
5094-OB16 18
5094-OB16S 18
5094-OB16SXT 18
5094-OB16XT 18
5094-OW4IS 18
5094-OW4ISXT 18
5094-OW8I 18
5094-OW8IXT 18

C

compatible Logix 5000 controllers 15
configuration
 Logix Designer application 87 - 104
 Connection category 95
 Counters category 97
 Events category 100
 General category 93
 module definition 94
 Module Info category 96
 Points category 98, 103, 104
 Time Sync category 102
 module tags 139 - 158
configure
 with Logix Designer application 48
connection 11
 fault handling
 5094-OB16 module 57 - 58
 inhibit the module 95
connection category 95, 113
 5094-IB16 module 95
 5094-OB16 module 95
 5094-OW8I module 95
connection types 27, 94
controller organizer
 monitor tag 105, 118
 view module tag 105, 118
counters category
 5094-IB16 module 97

D

data exchange
 data echo 60
data tags
 fault and status reporting
 input module 53
 output modules 61
data transmission
 multicast method 27
data types 27, 30
 available with I/O modules 27

define module

Logix Designer application 94

digital I/O module

configuration 107

digital input module

filter time 52

digital output module

short circuit protection 62
thermal switch 63

E

EDS

See electronic data sheet

electronic data sheet

 11

electronic keying

 36, 50, 94

events category

5094-IB16 module 100 - 101

F

fault and status reporting

 132 - 137

input module 53
output modules 61

fault handling

5094-OB16 module 57 - 58

filter time

digital input module 52

firmware

obtain from PCDC 48

G

general category

 93, 111

I

I/O status indicator

description 126 - 128
display 126 - 128

input filter

5094-IB16 module 52

input filter time

 98

L

load current

digital output module 62

Logix 5000 controllers

compatible with FLEX 5000 I/O modules 15
ownership of FLEX 5000 I/O modules 22

Logix Designer application 48
 configuration overview 25
 configure a FLEX 5000 I/O system 87 - 104
 Connection category 95
 connection types 27
 Counters category 97
 digital I/O module configuration 107
 Events category 100
 General category 93
 module definition 94
 Module Info category 96
 module tag definitions 139
 module tags
 5094-IB16 module 141 - 148
 5094-IB16S module 149 - 150
 5094-OB16 module 151 - 153
 5094-OB16S module 154 - 155
 5094-OW4IS module 156 - 157
 5094-OW8I module 157 - 158
 name module tag 140
 Points category 98, 103, 104
 tag editor 140
 Time Sync category 102
 troubleshooting 132 - 137
 view module tag 105, 118

M

masters 11
module definition
 dialog box 112
module feature
 data echo
 5094-OB16 modules 60
module info category 96
 5094-IB16 module 96
 5094-IB16S module 115
 5094-IB16SXT module 115
 5094-OB16 module 96, 115
 5094-OB16SXT module 115
 5094-OW8I module 96
module keying 20
module status indicator
 description 125
 display 126 - 128
module tag
 viewing 118
module tags
 5094-IB16 module 141 - 148
 5094-IB16S module 149 - 150
 5094-OB16 module 151 - 153
 5094-OB16S module 154 - 155
 5094-OW4IS module 156 - 157
 5094-OW8I module 157 - 158
 definitions 139
 fault and status reporting
 input module 53
 output modules 61
 naming 140
 tag editor 140
 viewing 105
module types 19
multicast
 data broadcast method 32

N

no load detection
 minimum time 62

O

ODVA 11
output behavior
 after connection fault
 5094-OB16 module 57 - 58
output state
 change time 56
ownership 22
 multiple owners of input modules 22

P

PCDC
 obtain firmware 48
PFD 11
 See probability of failure on demand.
PFH 11
 See probability of failure per hour.
points category
 5094-IB16 module 98 - 99
 5094-OB16 module 103
 5094-OW8I module 104
probability of failure
 on demand 11
 per hour 11
proof test 11

R

relay output module 19, 56, 84, 117, 131, 156,
 167, 172

S

SA Power status indicator
 description 124, 124
 display 126 - 128
safety module
 5094-IB16S 18
 5094-IB16SXT 18
 5094-OB16S 18
 5094-OB16SXT 18
 5094-OW4IS 18
 5094-OW4ISXT 18
safety network number 11
safety relay output module 56, 84, 117, 156,
 167, 172
short circuit protection
 digital output module 62
slaves 11
SNN 11
 See safety network number.
standard 11

standard module

- 5094-IB16 18
- 5094-IB16XT 18
- 5094-OB16 18
- 5094-OB16XT 18
- 5094-OW8I 18
- 5094-OW8IXT 18

status indicator, description

- I/O status indicator 126 - 128
- module status indicator 125
- SA Power status indicator 124, 124

status indicator, display

- I/O status indicator 126 - 128
- module status indicator 126 - 128
- SA Power status indicator 126 - 128

T**thermal switch**

- digital output module 63

time sync category

- 5094-IB16 module 102

time-scheduled output

- accuracy 64
- resolution 64

timestamping

- selection 98

troubleshooting 123 - 137

- connection category 134
- general category 133
- Logix Designer application 132 - 137
- module Info category 134
- module status indicator 20
- tag editor 137

U**unicast**

- data broadcast method 32

Notes:

Rockwell Automation Support

Use the following resources to access support information.

Technical Support Center	Knowledgebase Articles, How-to Videos, FAQs, Chat, User Forums, and Product Notification Updates.	https://rockwellautomation.custhelp.com/
Local Technical Support Phone Numbers	Locate the phone number for your country.	http://www.rockwellautomation.com/global/support/get-support-now.page
Direct Dial Codes	Find the Direct Dial Code for your product. Use the code to route your call directly to a technical support engineer.	http://www.rockwellautomation.com/global/support/direct-dial.page
Literature Library	Installation Instructions, Manuals, Brochures, and Technical Data.	http://www.rockwellautomation.com/global/literature-library/overview.page
Product Compatibility and Download Center (PCDC)	Get help determining how products interact, check features and capabilities, and find associated firmware.	http://www.rockwellautomation.com/global/support/pcdc.page

Documentation Feedback

Your comments will help us serve your documentation needs better. If you have any suggestions on how to improve this document, complete the How Are We Doing? form at http://literature.rockwellautomation.com/idc/groups/literature/documents/du/ra-du002_-en-e.pdf.

Rockwell Automation maintains current product environmental information on its website at <http://www.rockwellautomation.com/rockwellautomation/about-us/sustainability-ethics/product-environmental-compliance.page>.

Allen-Bradley, CompactLogix, ControlLogix, FLEX 5000, GuardLogix, Integrated Architecture, Logix 5000, Rockwell Automation, Rockwell Software, RSNetWorx, Studio 5000, and Studio 5000 Logix Designer are trademarks of Rockwell Automation, Inc.

CIP, CIP Safety, CIP Sync, ControlNet, DeviceNet, and EtherNet/IP are trademarks of ODVA, Inc.

Trademarks not belonging to Rockwell Automation are property of their respective companies.

Rockwell Otomasyon Ticaret A.Ş., Kar Plaza İş Merkezi E Blok Kat:6 34752 İçerenköy, İstanbul, Tel: +90 (216) 5698400

www.rockwellautomation.com

Power, Control and Information Solutions Headquarters

Americas: Rockwell Automation, 1201 South Second Street, Milwaukee, WI 53204-2496 USA, Tel: (1) 414.382.2000, Fax: (1) 414.382.4444

Europe/Middle East/Africa: Rockwell Automation NV, Pegasus Park, De Kleetlaan 12a, 1831 Diegem, Belgium, Tel: (32) 2 663 0600, Fax: (32) 2 663 0640

Asia Pacific: Rockwell Automation, Level 14, Core F, Cyberport 3, 100 Cyberport Road, Hong Kong, Tel: (852) 2887 4788, Fax: (852) 2508 1846

Publication 5094-UM001D-EN-P - July 2019

Supersedes Publication 5094-UM001C-EN-P - September 2018

Copyright © 2019 Rockwell Automation, Inc. All rights reserved. Printed in the U.S.A.



Allen-Bradley

FLEX 5000 Standard and Safety I/O Modules

User Manual

